

sistema expositivo móvel

ana laura assumpção | gabriela villa | inna mascarin | isabelle mensato | letícia aranda | paula pacheco | renata gonçalves

* PARTIDO

- Elevado do solo
depende de cada mm,
↑ a altura

- perfil viga-pilar

I

- piso passagem

- cubo módulo 2,5x2,5
construção ou desconstrução

- pilar / viga
aco cortain

- vedação
opaca ou translúcida

↓
aco cortain
chapa

↓
~~vidro espelhado~~
chapa metálica
perfurada

→ só fechado ou só aberto.

partido
aula 26-06-2012

sistema expositivo móvel



áreas-objeto
percurso

sistema expositivo móvel



área-objeto

01 . 02 . 03 . 04 . 05 . 06 . 07

lamem . gabriela

implantação

sistema expositivo móvel

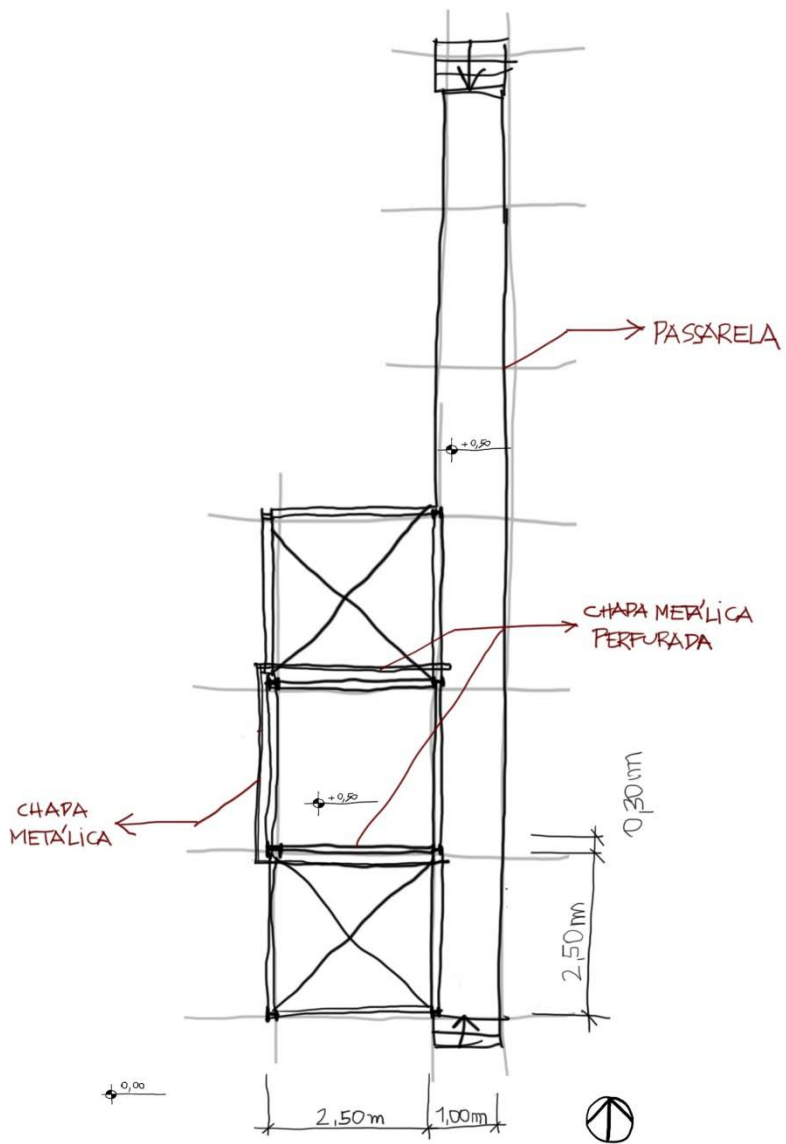

área-objeto

01 . 02 . 03 . 04 . 05 . 06 . 07

lamem . gabriela

planta baixa

sistema expositivo móvel

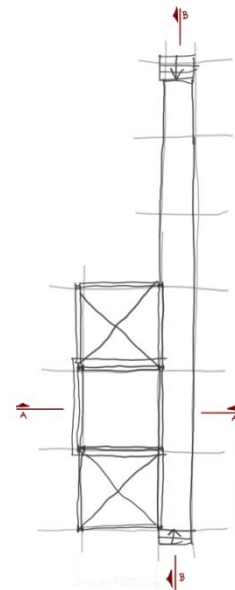
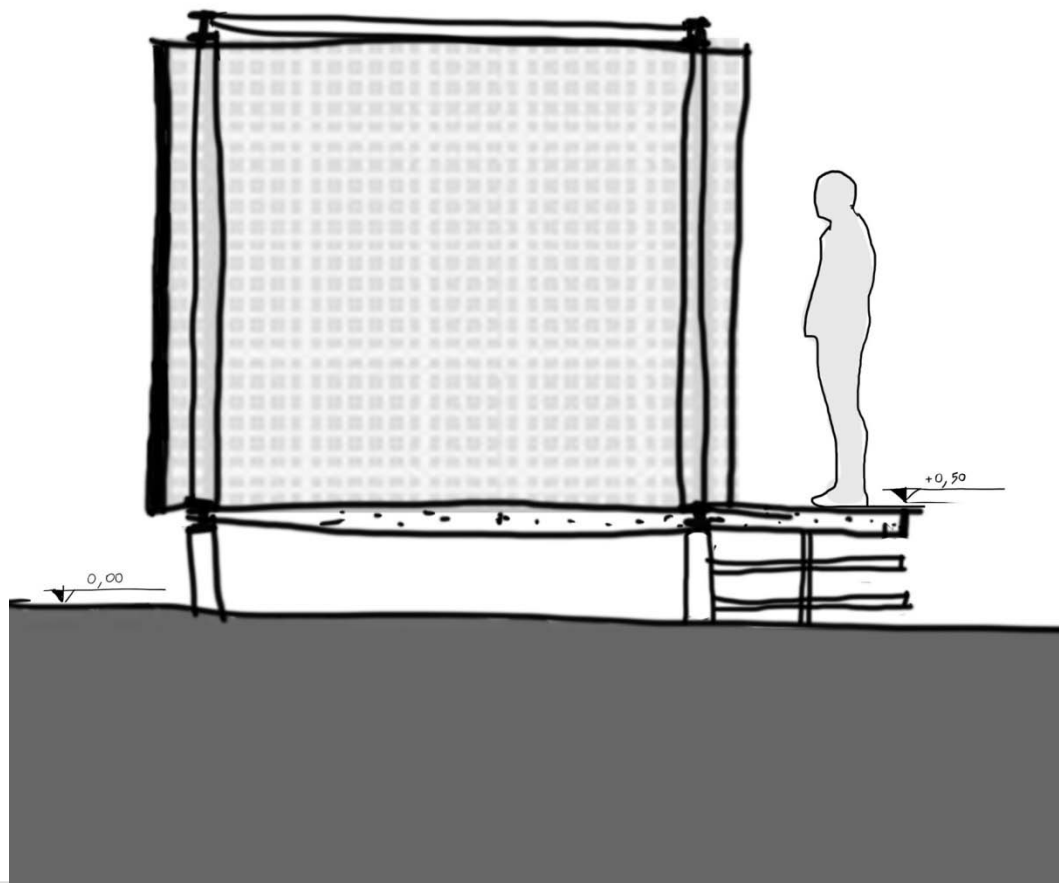

área-objeto

01 . 02 . 03 . 04 . 05 . 06 . 07

lamem . gabriela

cutte A-A

sistema expositivo móvel

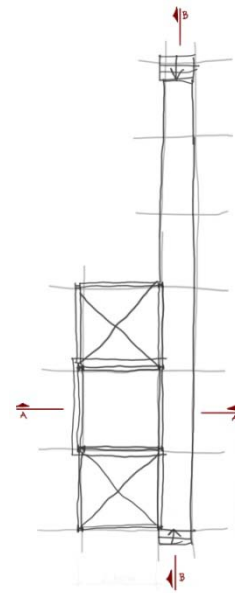
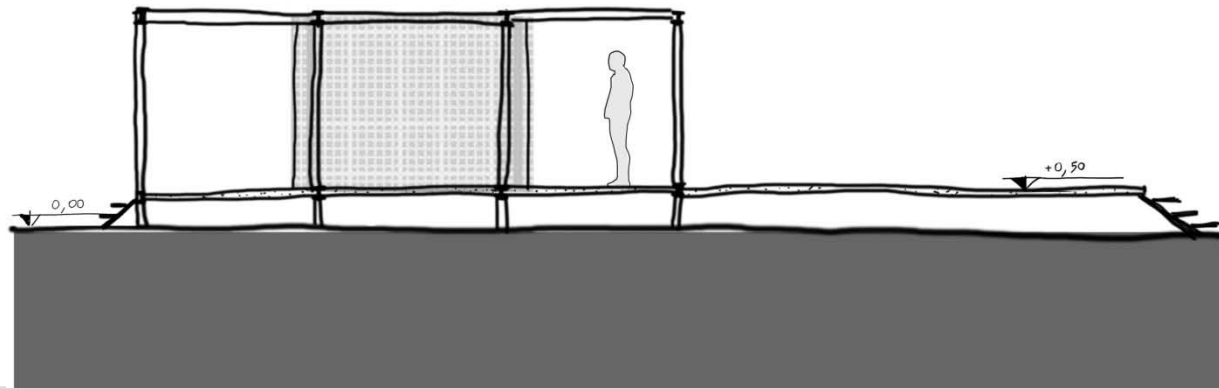

área-objeto

01 . 02 . 03 . 04 . 05 . 06 . 07

lamem . gabriela

corte B-B

sistema expositivo móvel

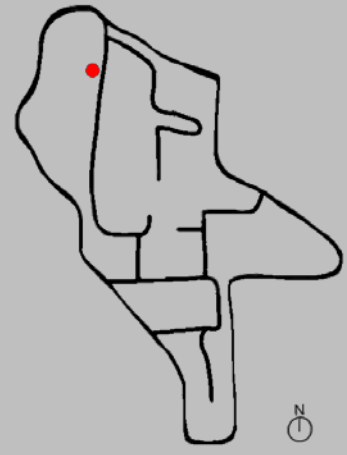
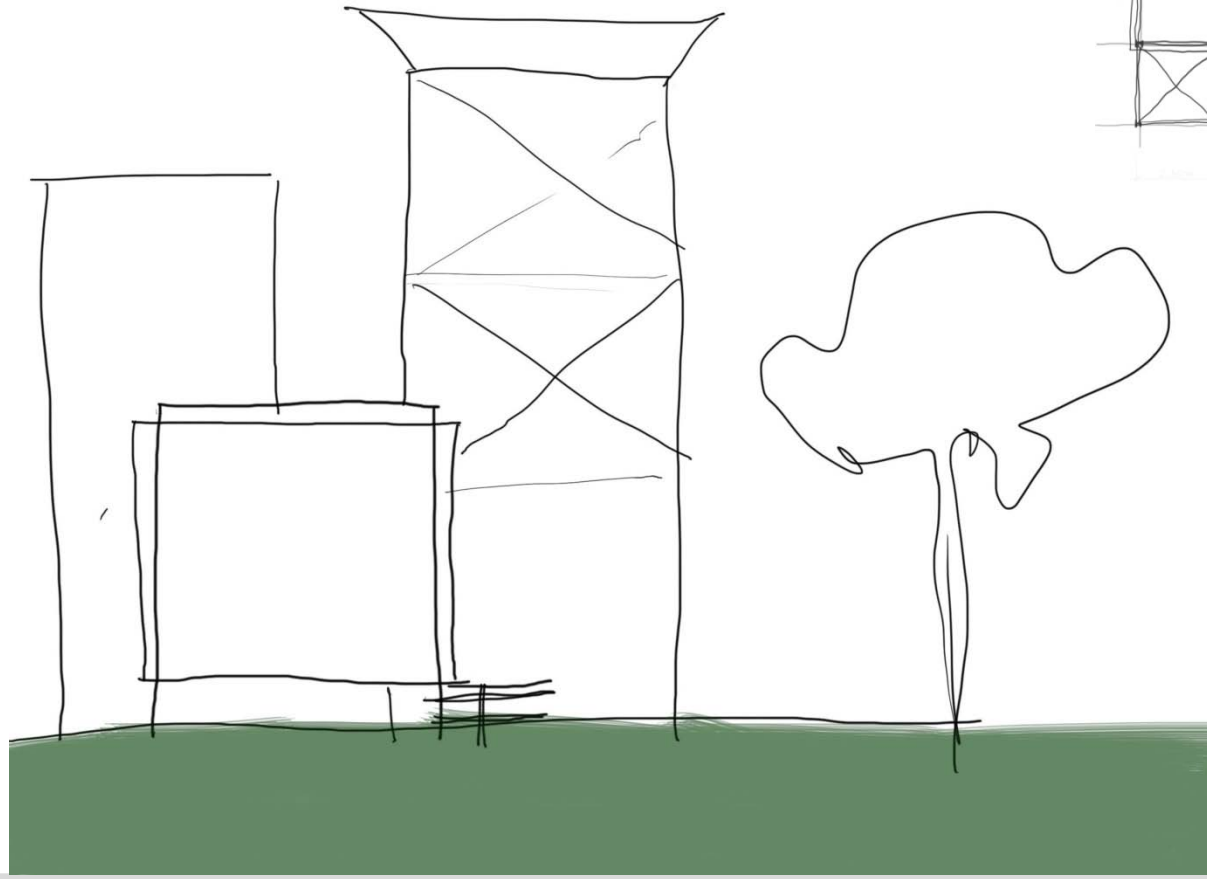

área-objeto

01 . 02 . 03 . 04 . 05 . 06 . 07

lamem . gabriela

elevação sul

sistema expositivo móvel

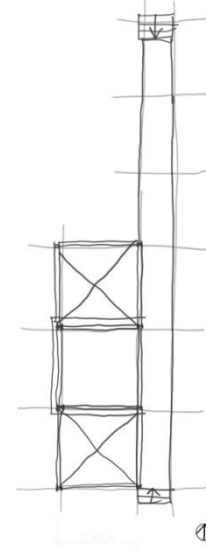
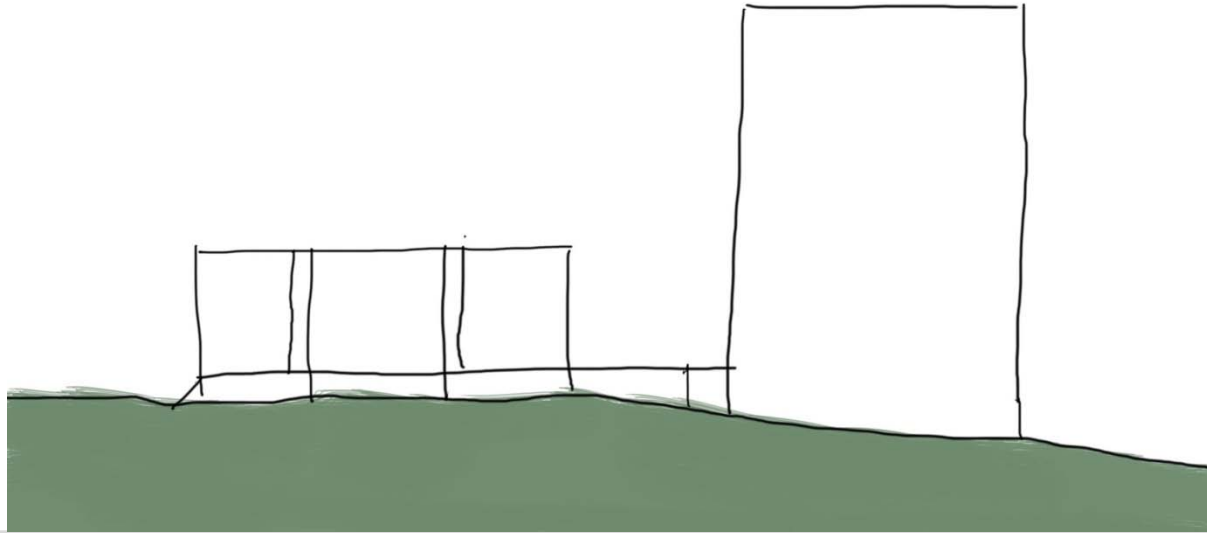

área-objeto

01 . 02 . 03 . 04 . 05 . 06 . 07

lamem . gabriela

elevação leste

sistema expositivo móvel

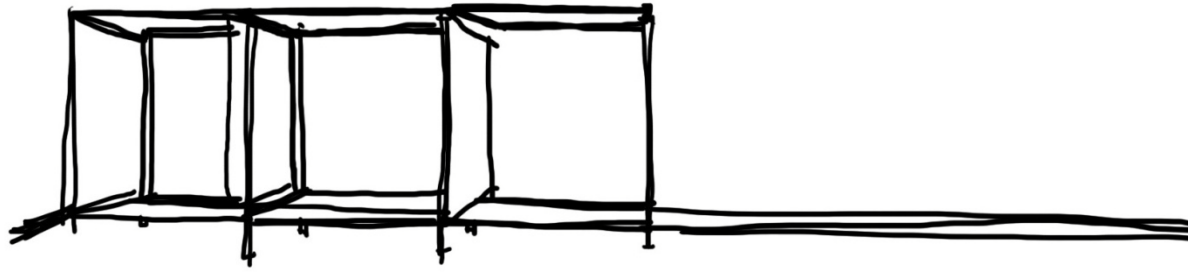

área-objeto

01 . 02 . 03 . 04 . 05 . 06 . 07

lamem . gabriela

perspectiva

sistema expositivo móvel

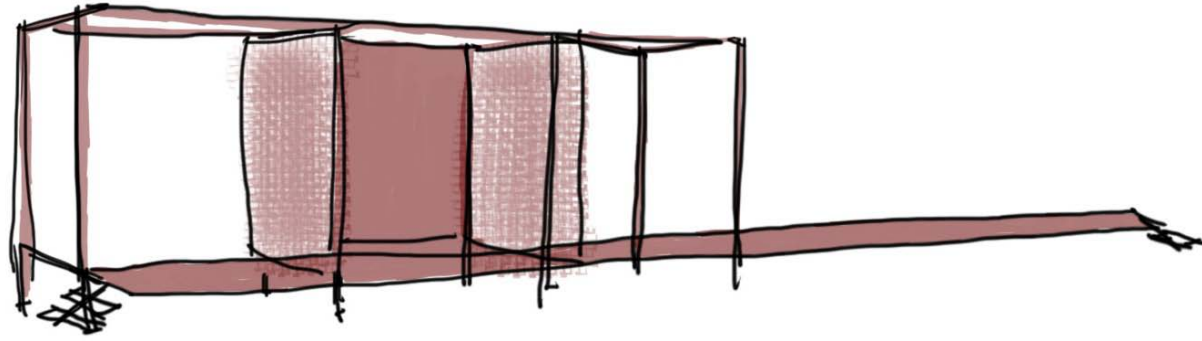

área-objeto

01 . 02 . 03 . 04 . 05 . 06 . 07

lamem . gabriela

perspectiva

sistema expositivo móvel

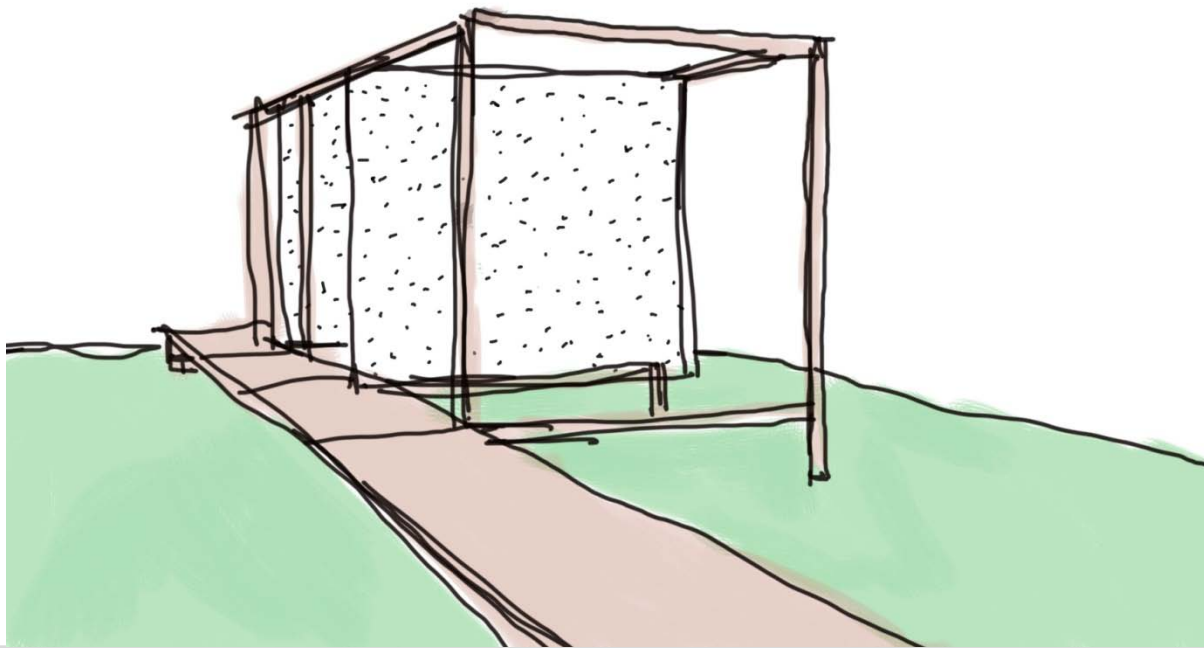

área-objeto

01 . 02 . 03 . 04 . 05 . 06 . 07

lamem . gabriela

perspectiva

sistema expositivo móvel

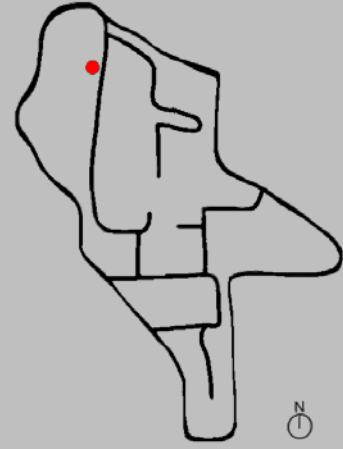
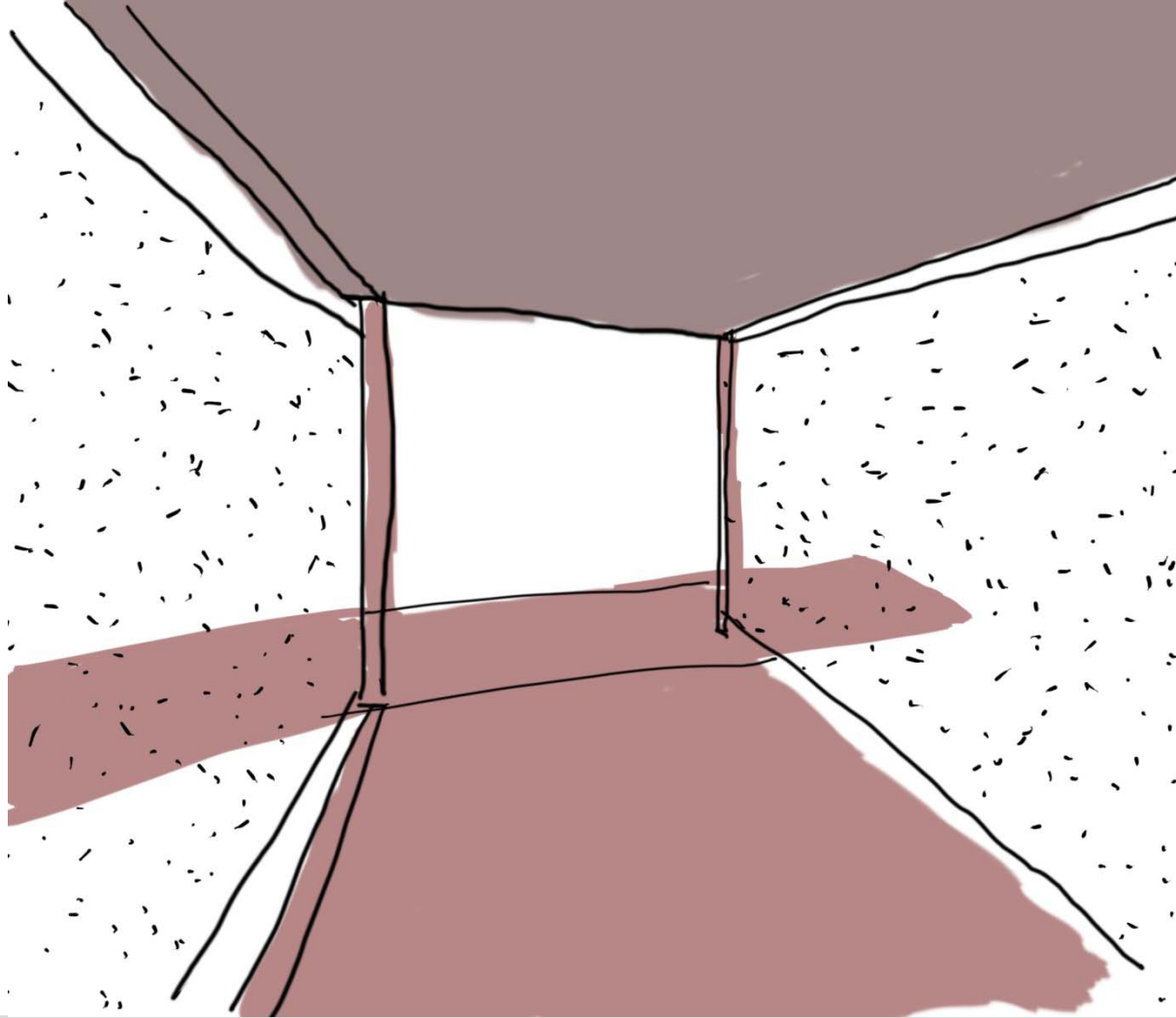

área-objeto

01 . 02 . 03 . 04 . 05 . 06 . 07

lamem . gabriela

perspectiva interna

sistema expositivo móvel



área-objeto

01 . 02 . 03 . 04 . 05 . 06 . 07

lamem . gabriela

montagem

sistema expositivo móvel



área-objeto
01 . **02** . 03 . 04 . 05 . 06 . 07

pq . inna
implantação

sistema expositivo móvel

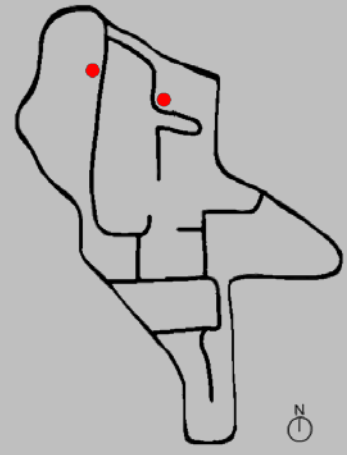
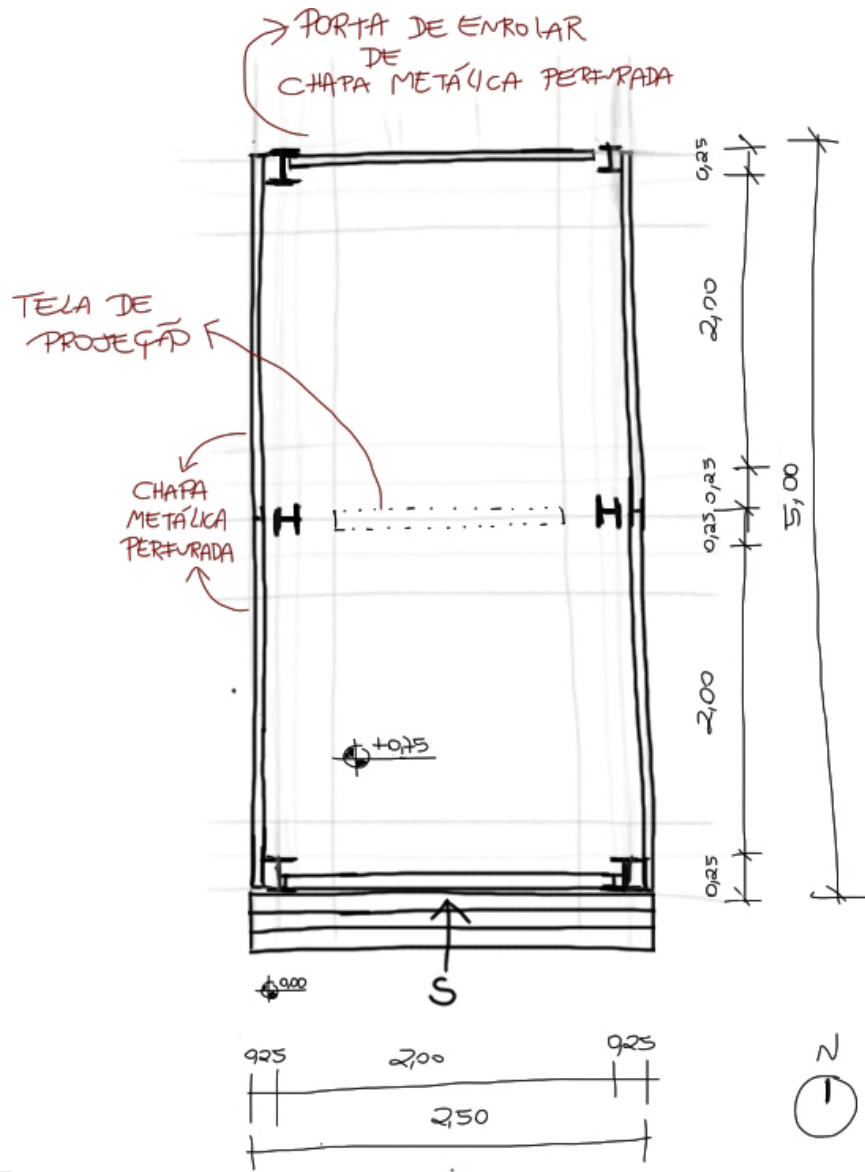

área-objeto

01 . 02 . 03 . 04 . 05 . 06 . 07

pq . inna
planta baixa

sistema expositivo móvel

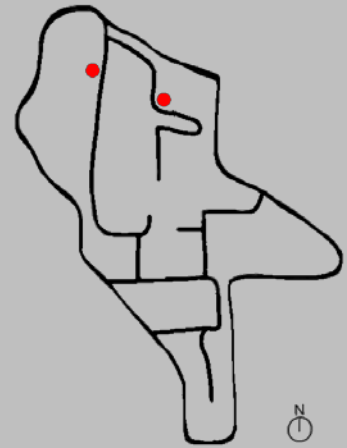
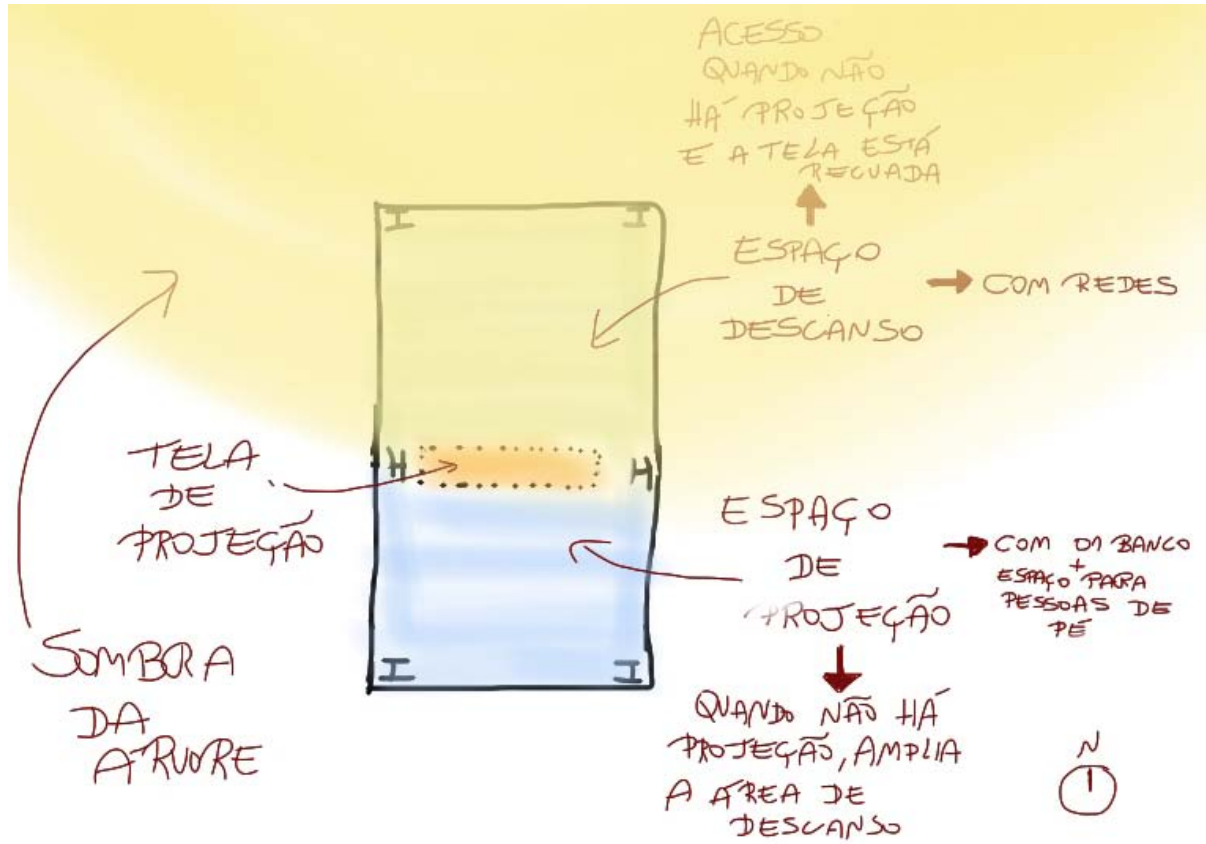

área-objeto

01 . 02 . 03 . 04 . 05 . 06 . 07

pq . inna

áreas de vivência

sistema expositivo móvel

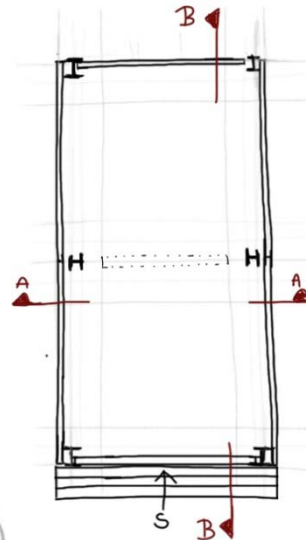
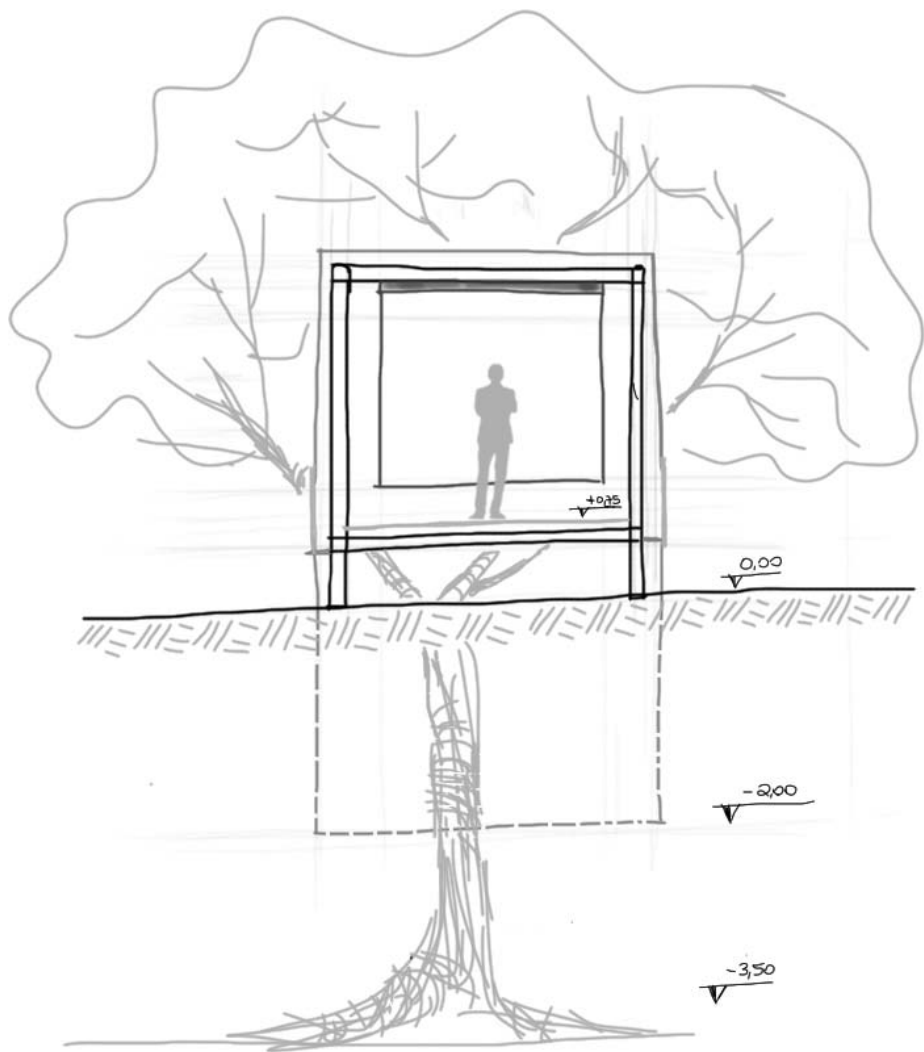

⊖z



área-objeto

01 . 02 . 03 . 04 . 05 . 06 . 07

pq . inna

corte A-A

sistema expositivo móvel

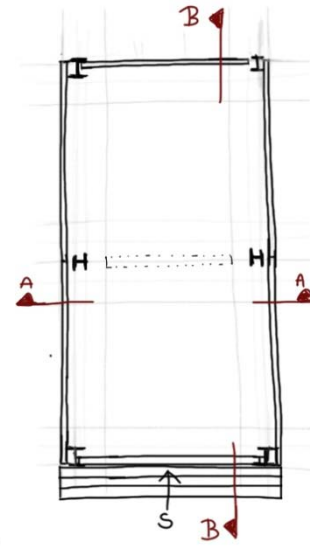
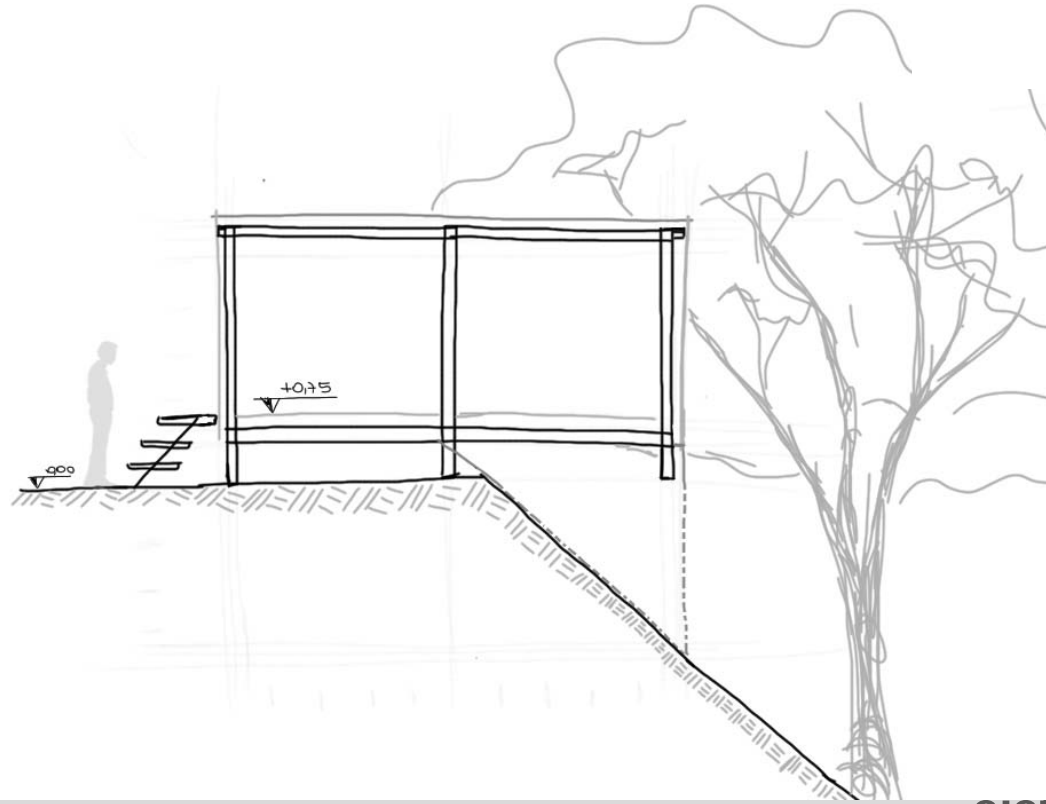

02



área-objeto

01 . 02 . 03 . 04 . 05 . 06 . 07

pq . inna

corte B-B

sistema expositivo móvel

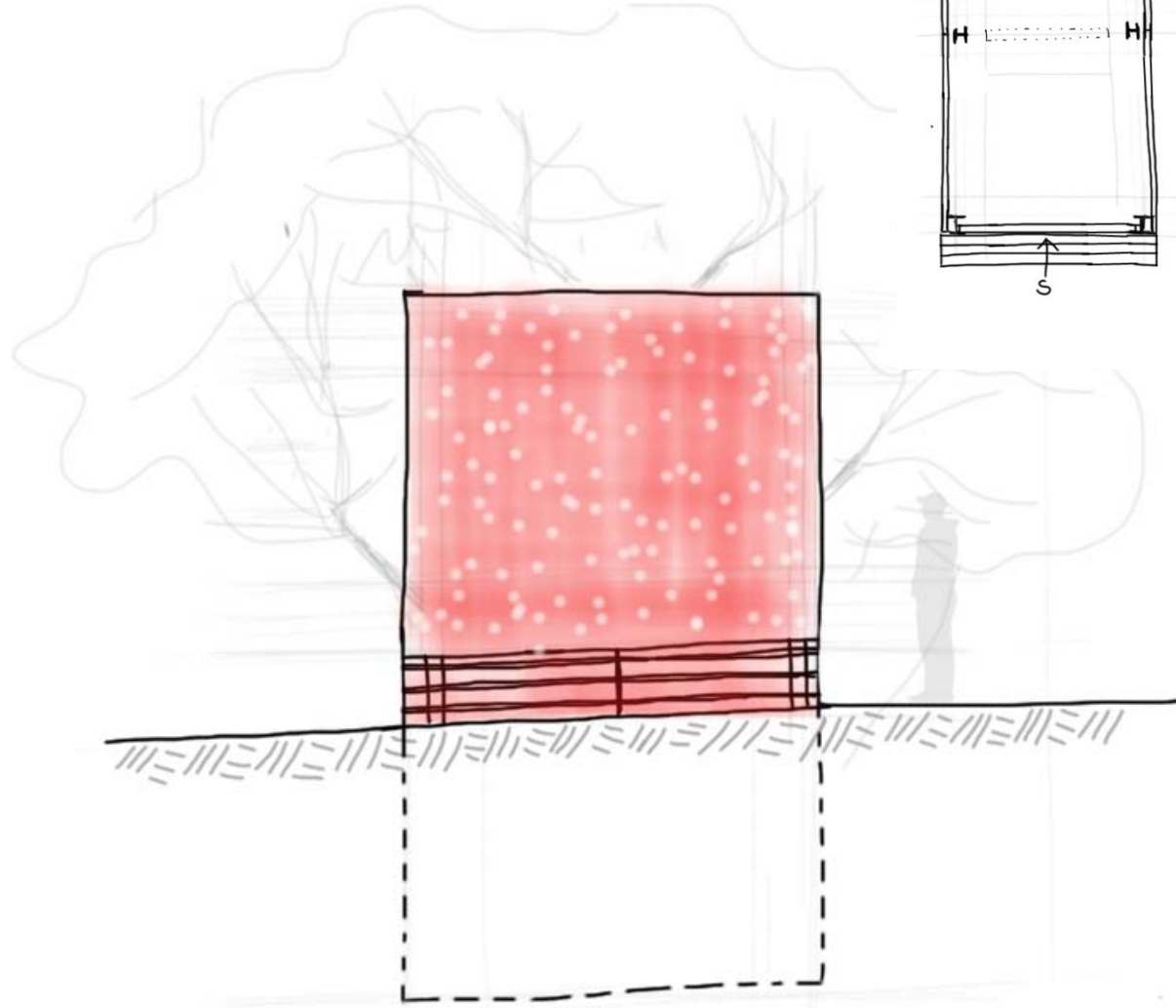

⊖z

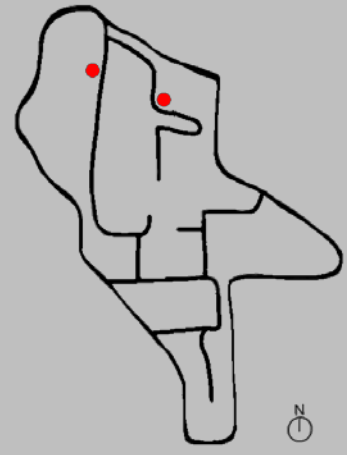

área-objeto

01 . **02** . 03 . 04 . 05 . 06 . 07

pq . inna

elevação norte

sistema expositivo móvel

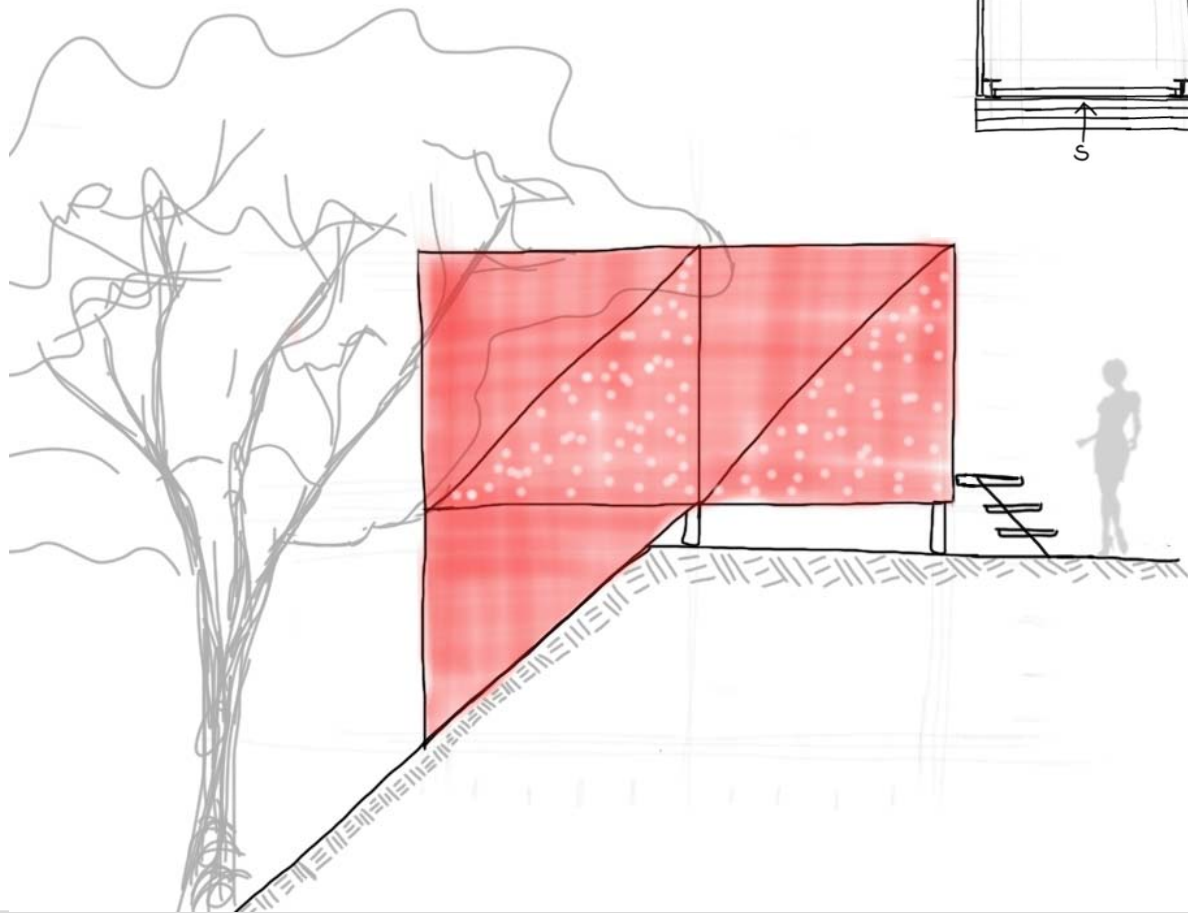

N

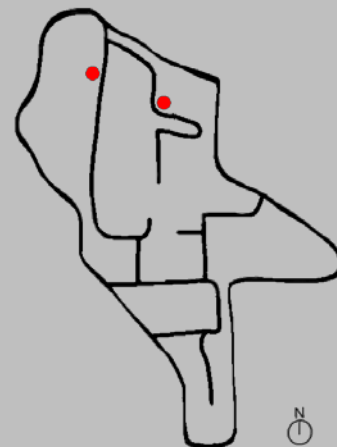

área-objeto

01 . 02 . 03 . 04 . 05 . 06 . 07

pq . inna

elevação oeste

sistema expositivo móvel

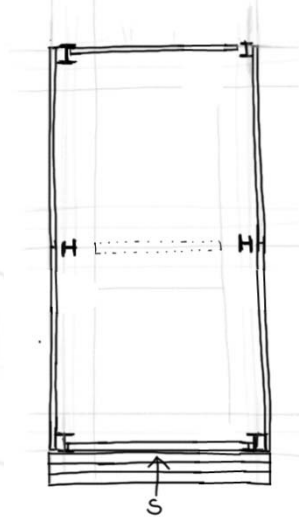
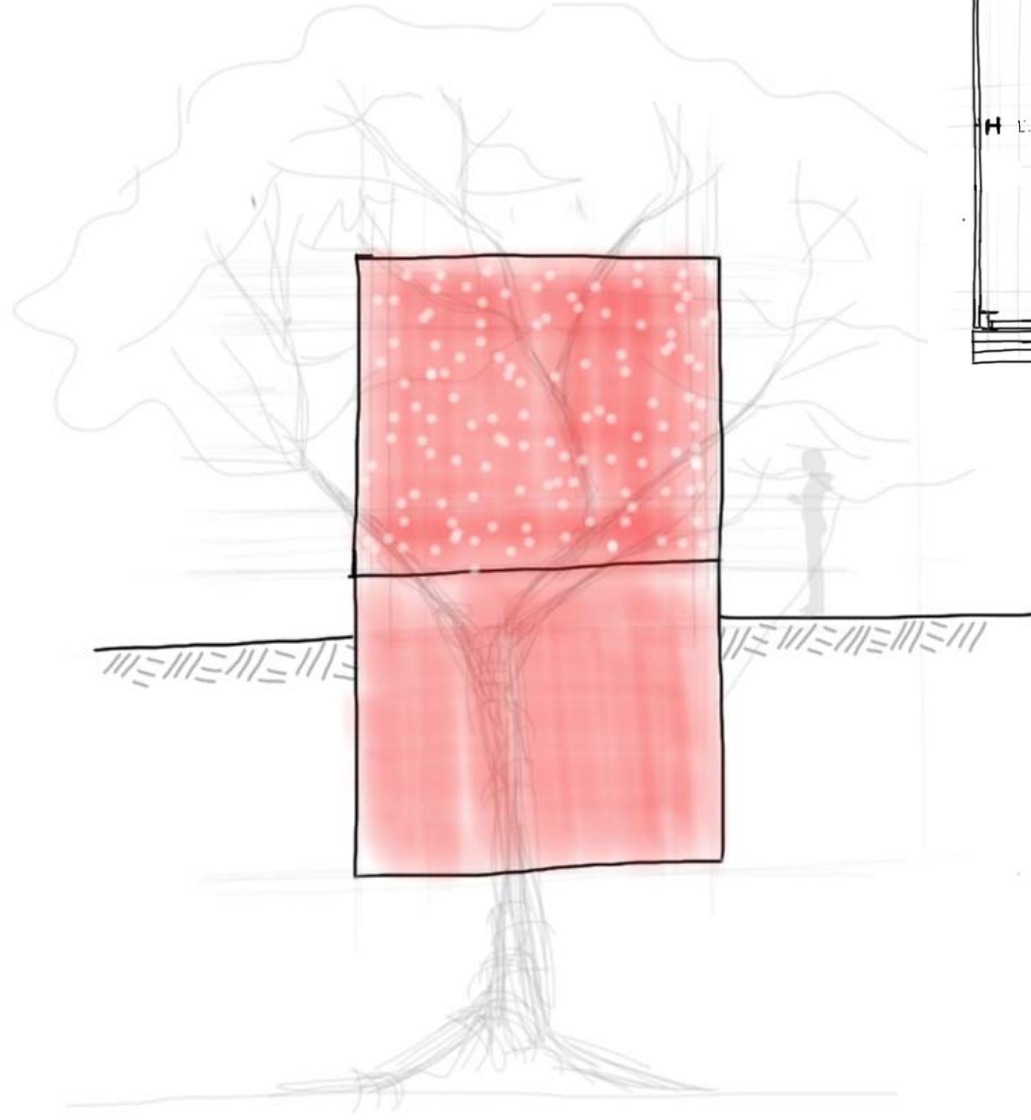

⊖z

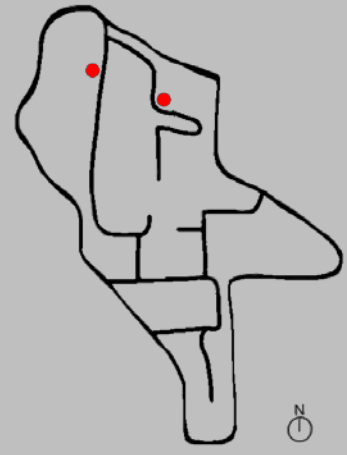

área-objeto

01 . **02** . 03 . 04 . 05 . 06 . 07

pq . inna
elevação sul

sistema expositivo móvel

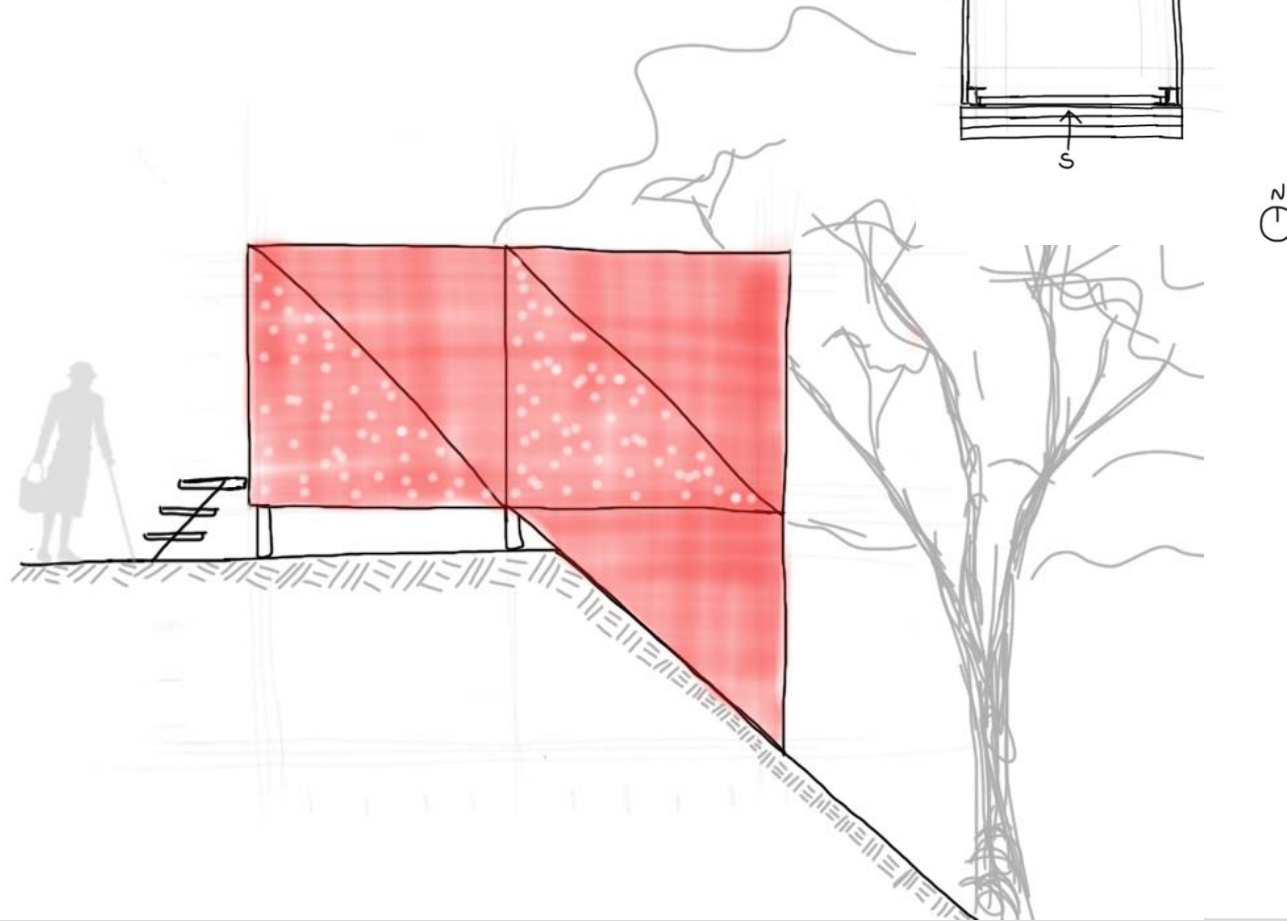

área-objeto

01 . 02 . 03 . 04 . 05 . 06 . 07

pq . inna

elevação leste

sistema expositivo móvel

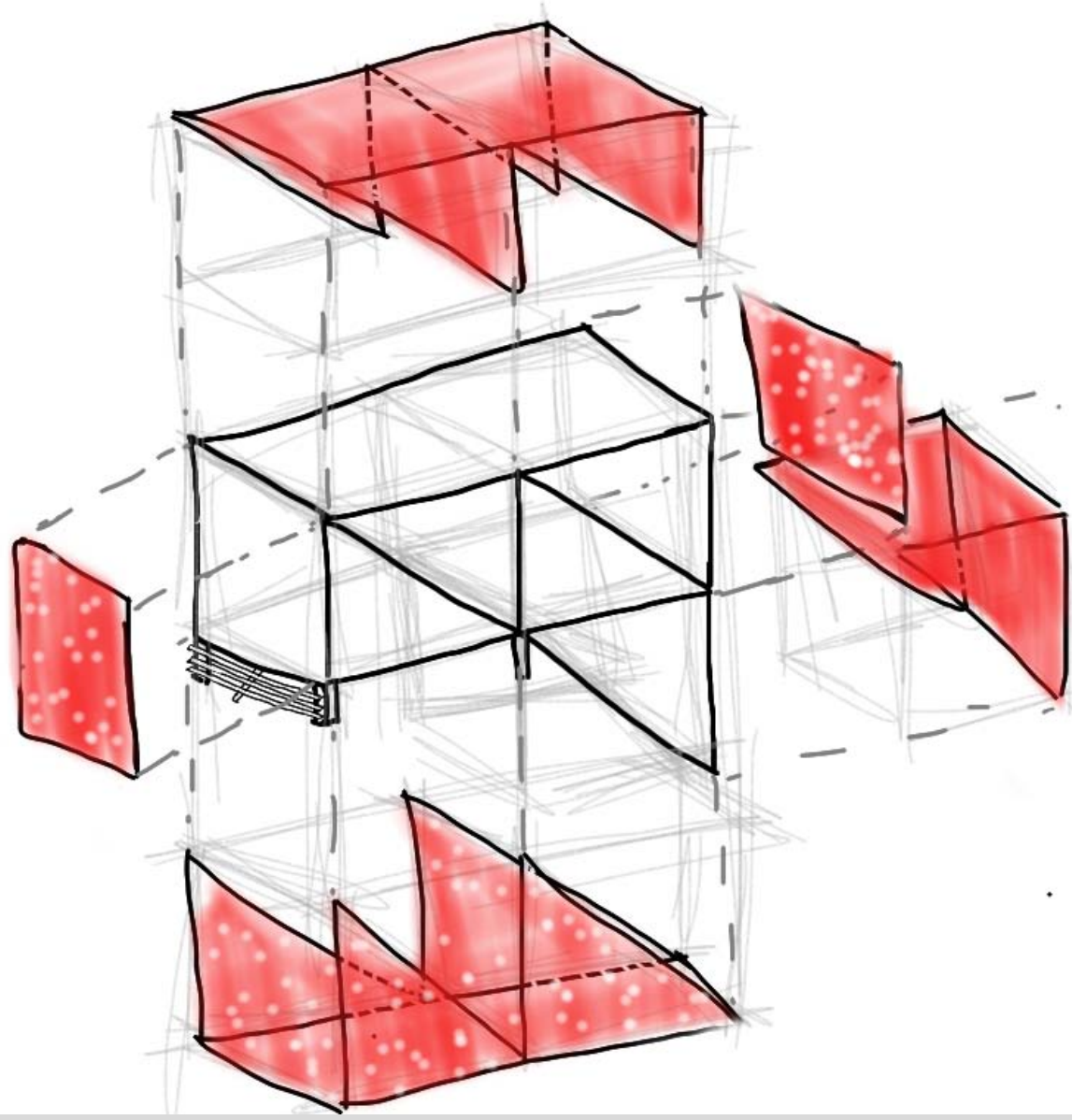

área-objeto

01 . **02** . 03 . 04 . 05 . 06 . 07

pq . inna

perspectiva explodida

sistema expositivo móvel

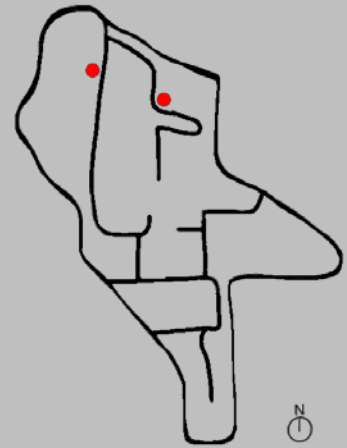
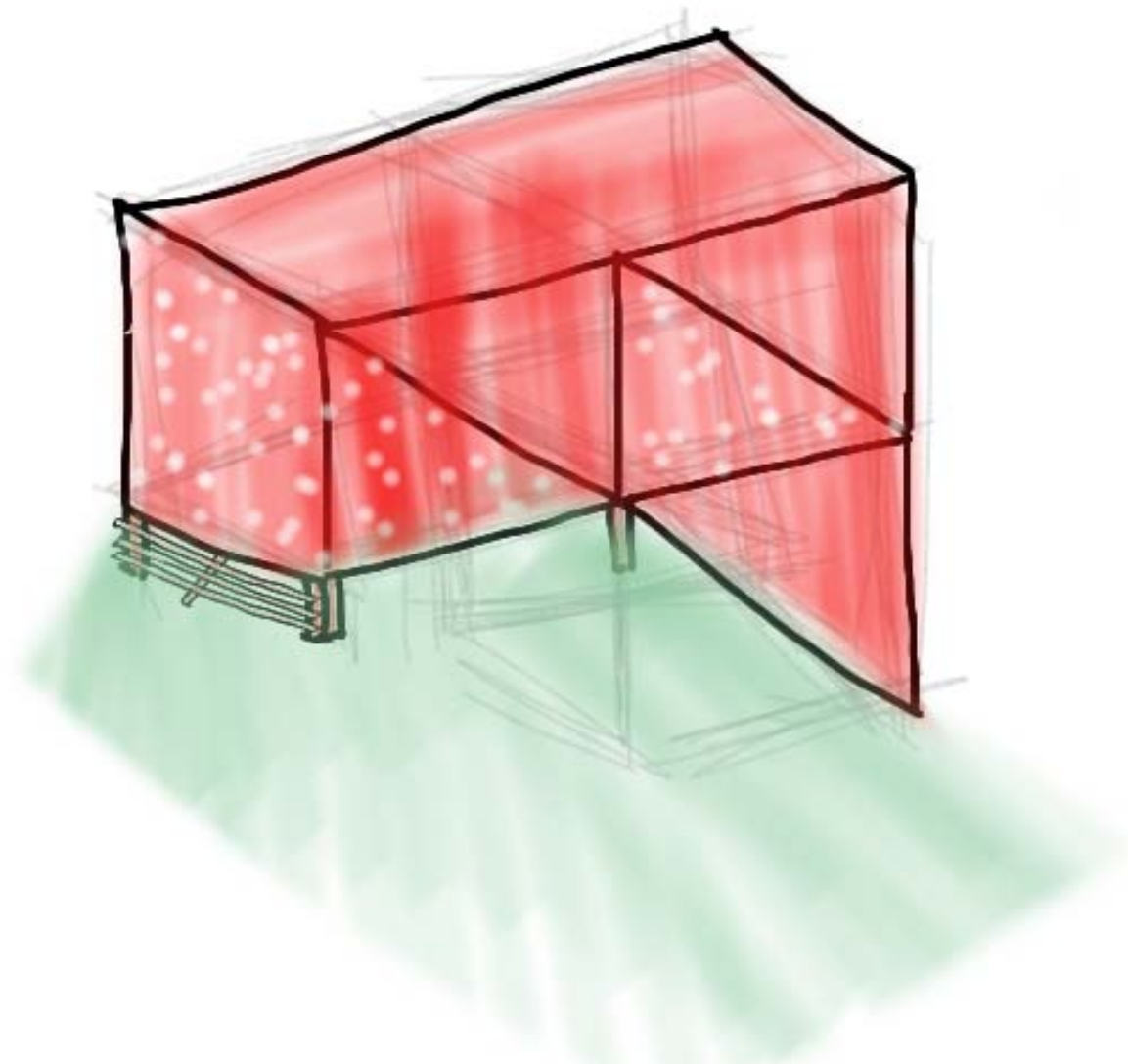

área-objeto

01 . **02** . 03 . 04 . 05 . 06 . 07

pq . inna

perspectiva – folie fechado

sistema expositivo móvel

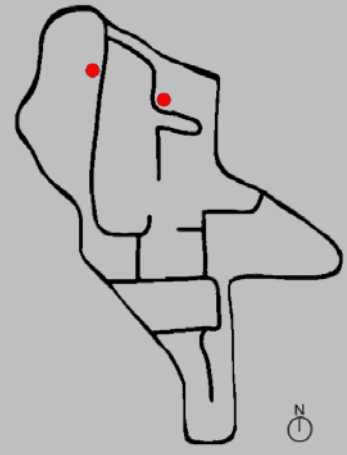
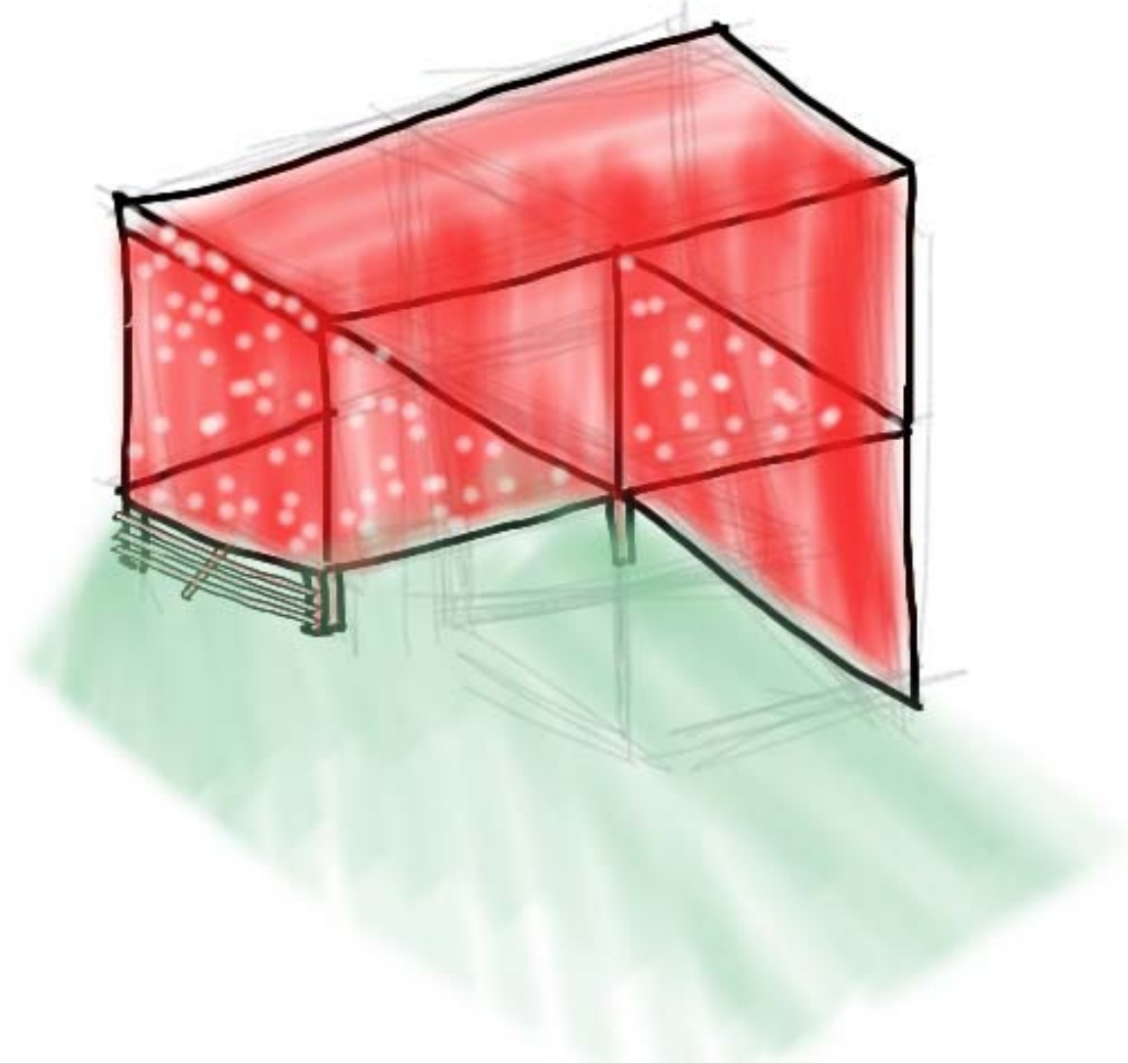

área-objeto

01 . **02** . 03 . 04 . 05 . 06 . 07

pq . inna

perspectiva - folie aberto

sistema expositivo móvel

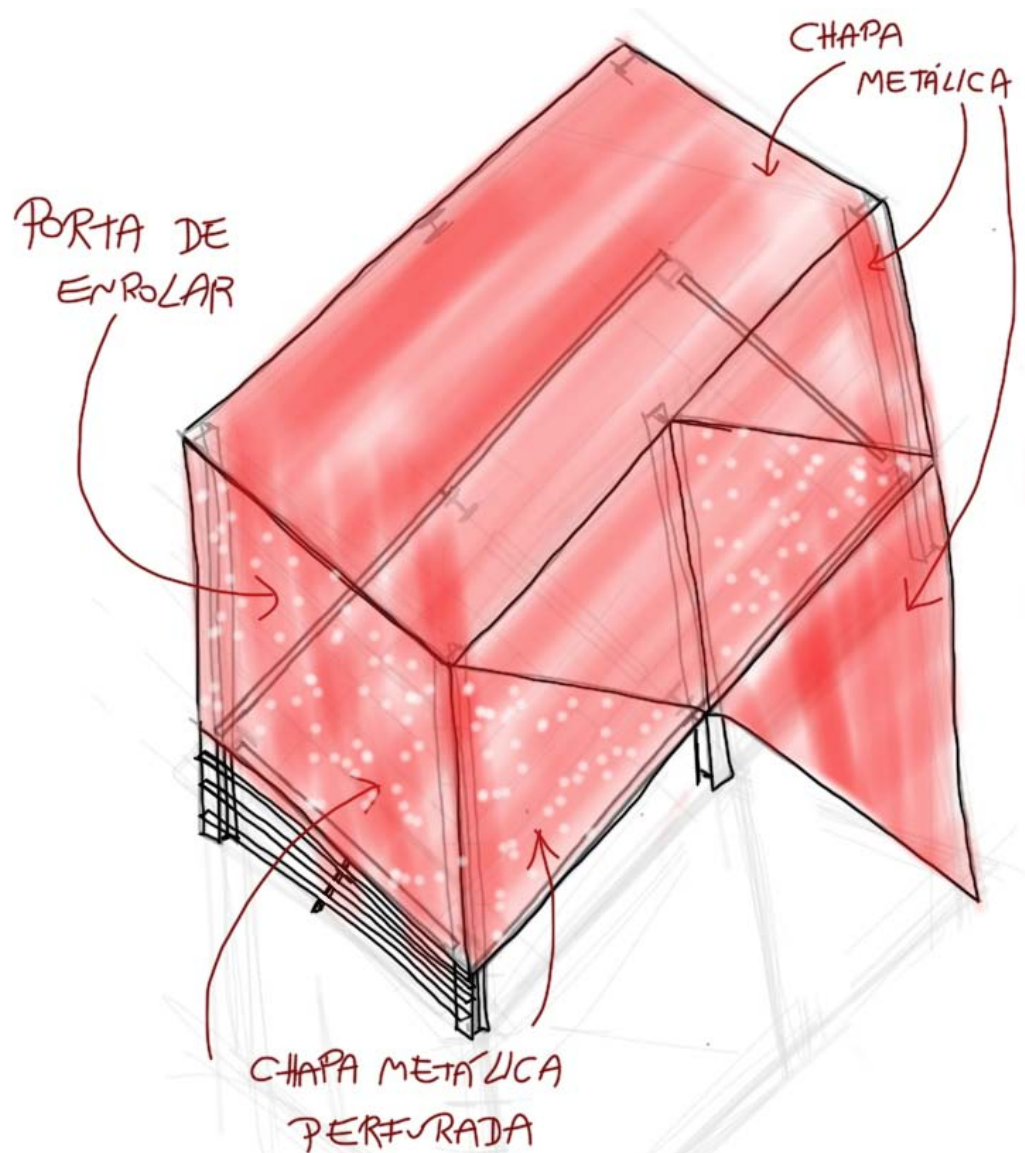

área-objeto

01 . 02 . 03 . 04 . 05 . 06 . 07

pq . inna

perspectiva isométrica

sistema expositivo móvel



área-objeto

01 . **02** . 03 . 04 . 05 . 06 . 07

pq . inna
montagem

sistema expositivo móvel

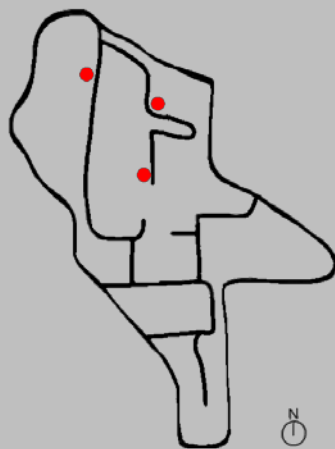

área-objeto

01 . 02 . **03** . 04 . 05 . 06 . 07

química . ana laura
implantação

sistema expositivo móvel

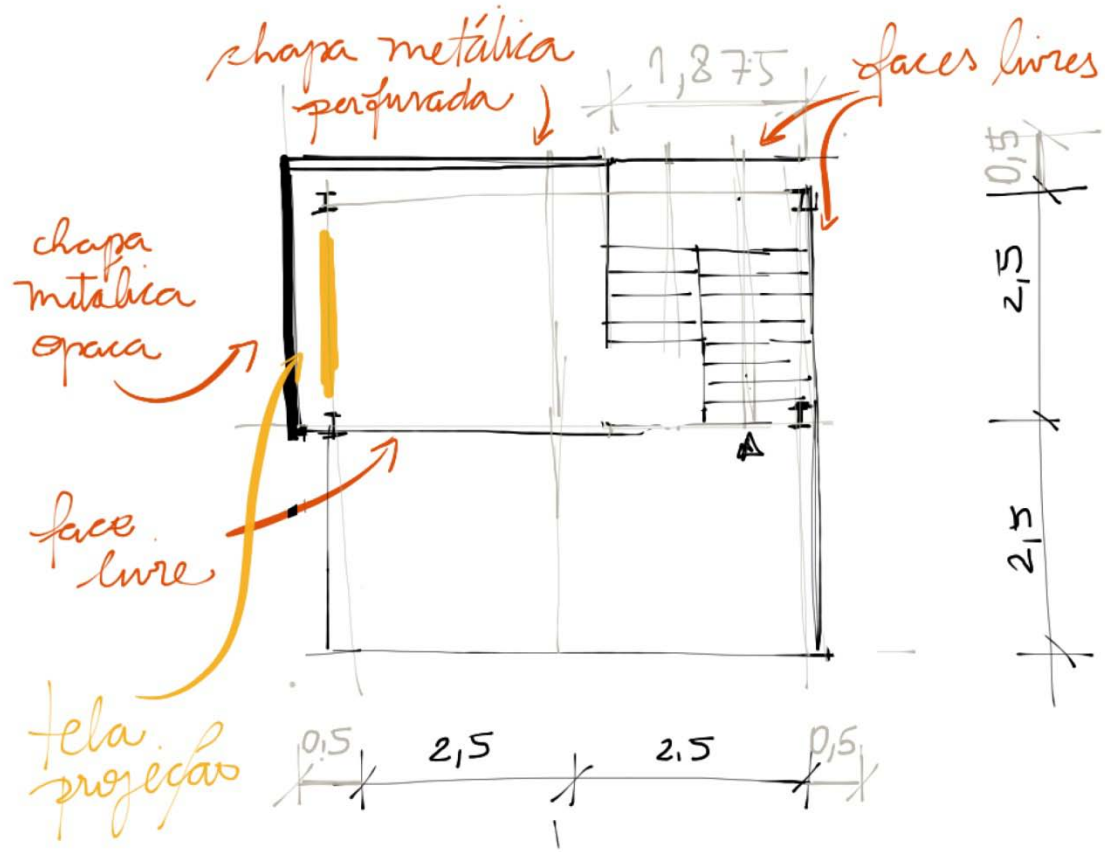

área-objeto

01 . 02 . **03** . 04 . 05 . 06 . 07

química . ana laura

planta baixa

sistema expositivo móvel

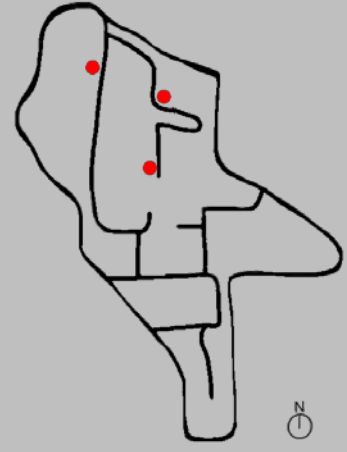
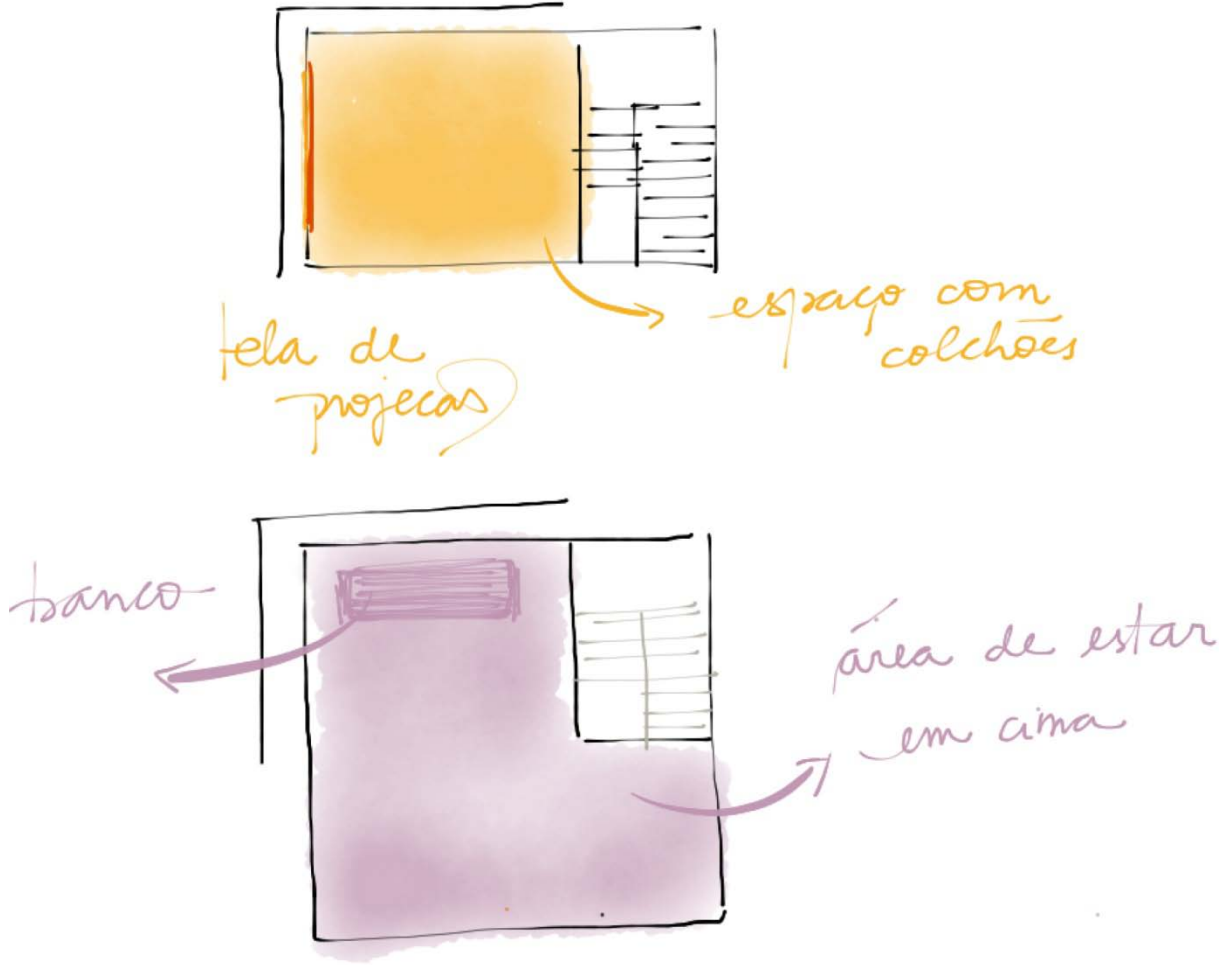

área-objeto

01 . 02 . **03** . 04 . 05 . 06 . 07

química . ana laura

áreas de vivência

sistema expositivo móvel

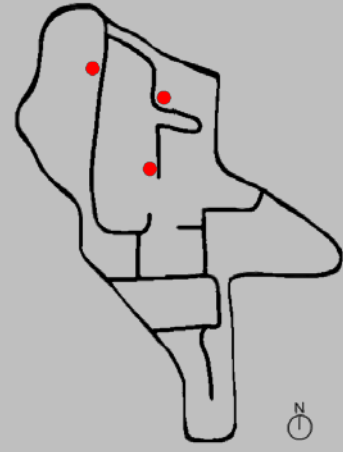
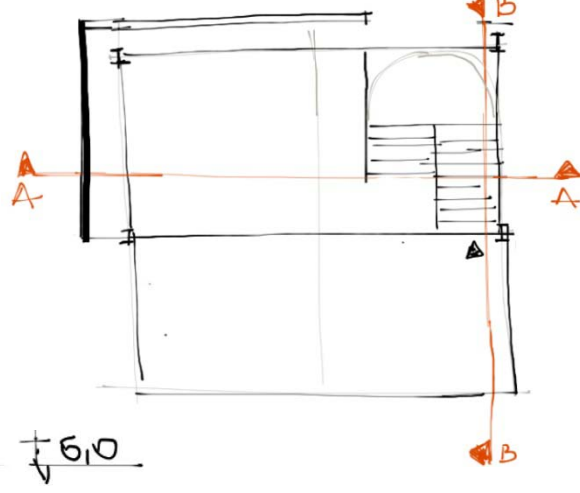
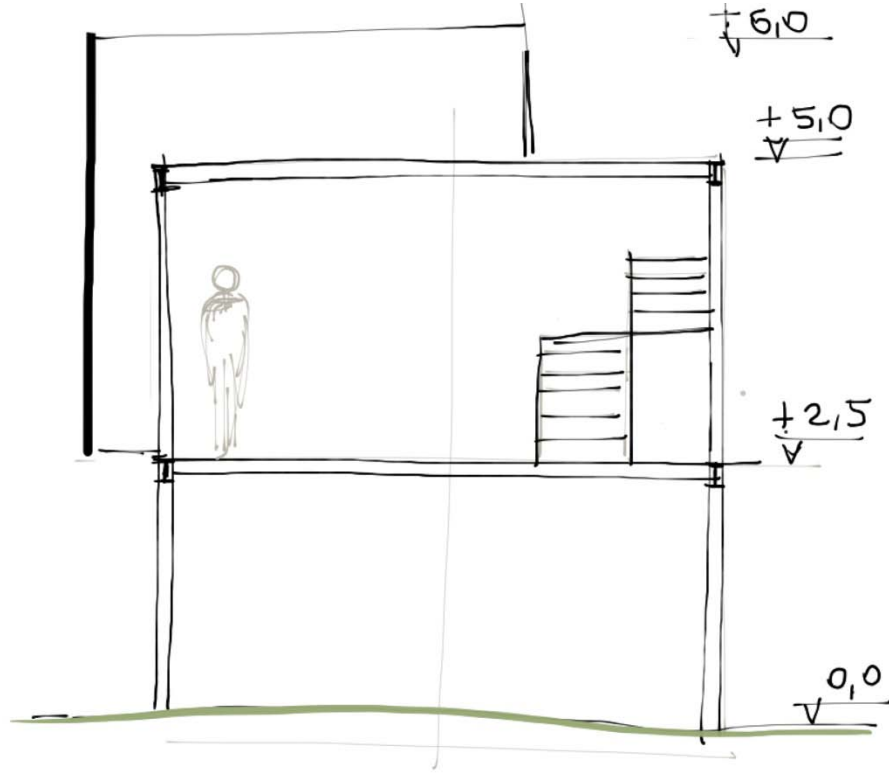

área-objeto

01 . 02 . **03** . 04 . 05 . 06 . 07

química . ana laura

corte A-A

sistema expositivo móvel

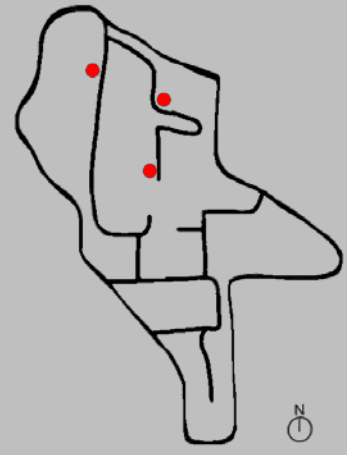
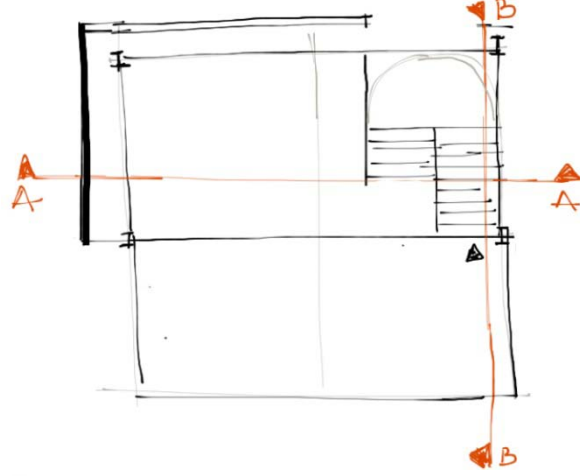
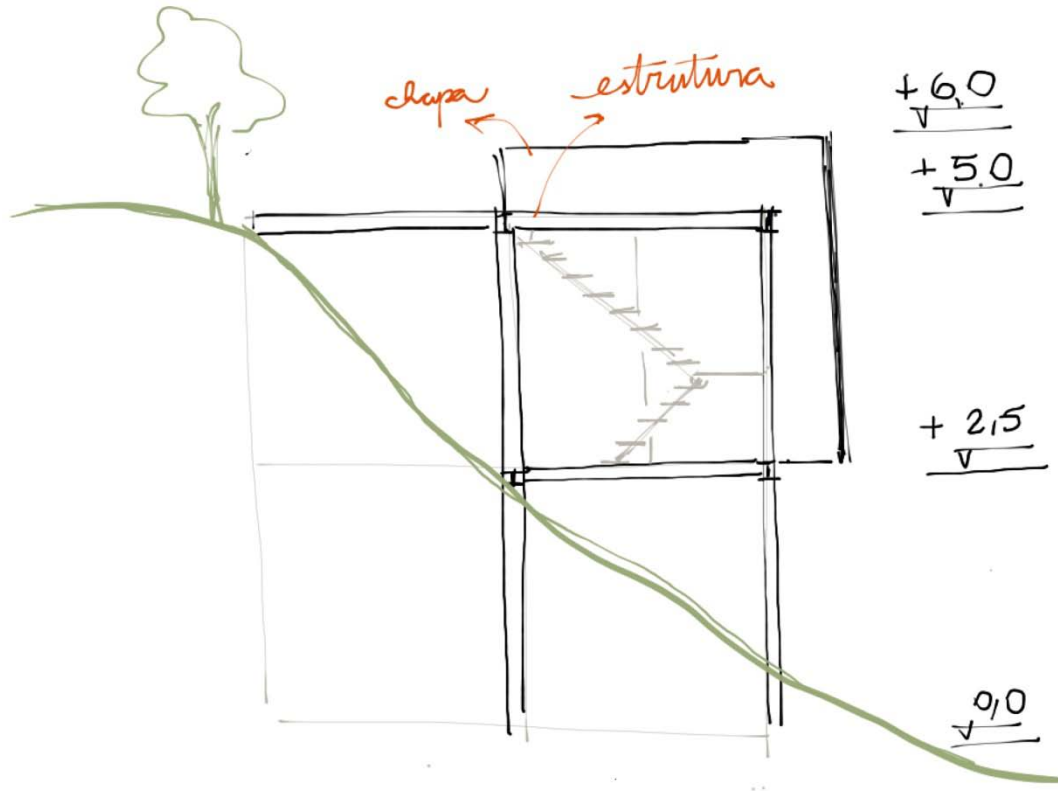

área-objeto

01 . 02 . **03** . 04 . 05 . 06 . 07

química . ana laura

corte B-B

sistema expositivo móvel

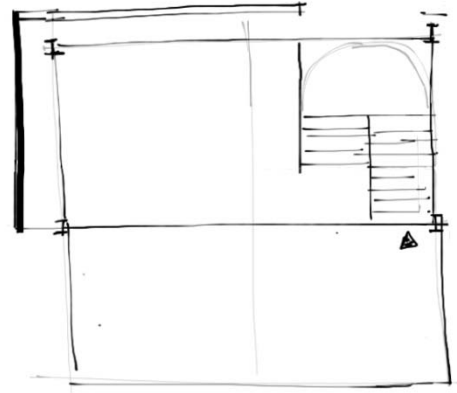
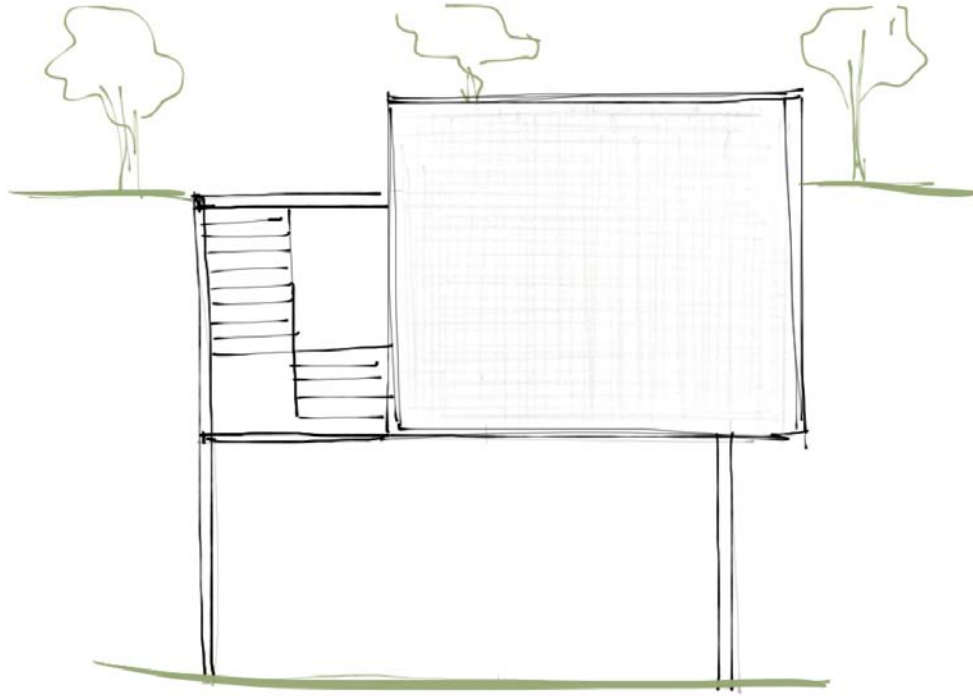

área-objeto

01 . 02 . **03** . 04 . 05 . 06 . 07

química . ana laura

elevação norte

sistema expositivo móvel

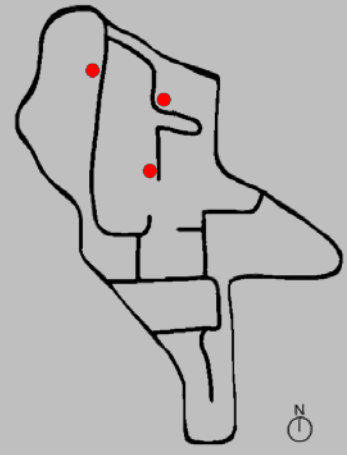
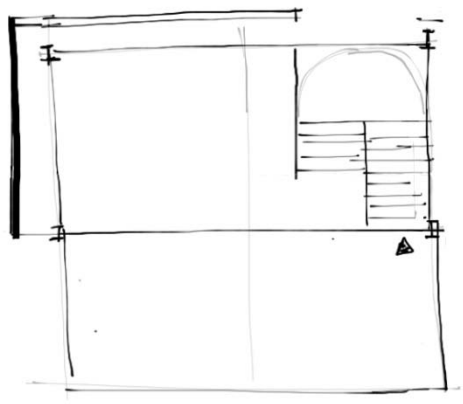
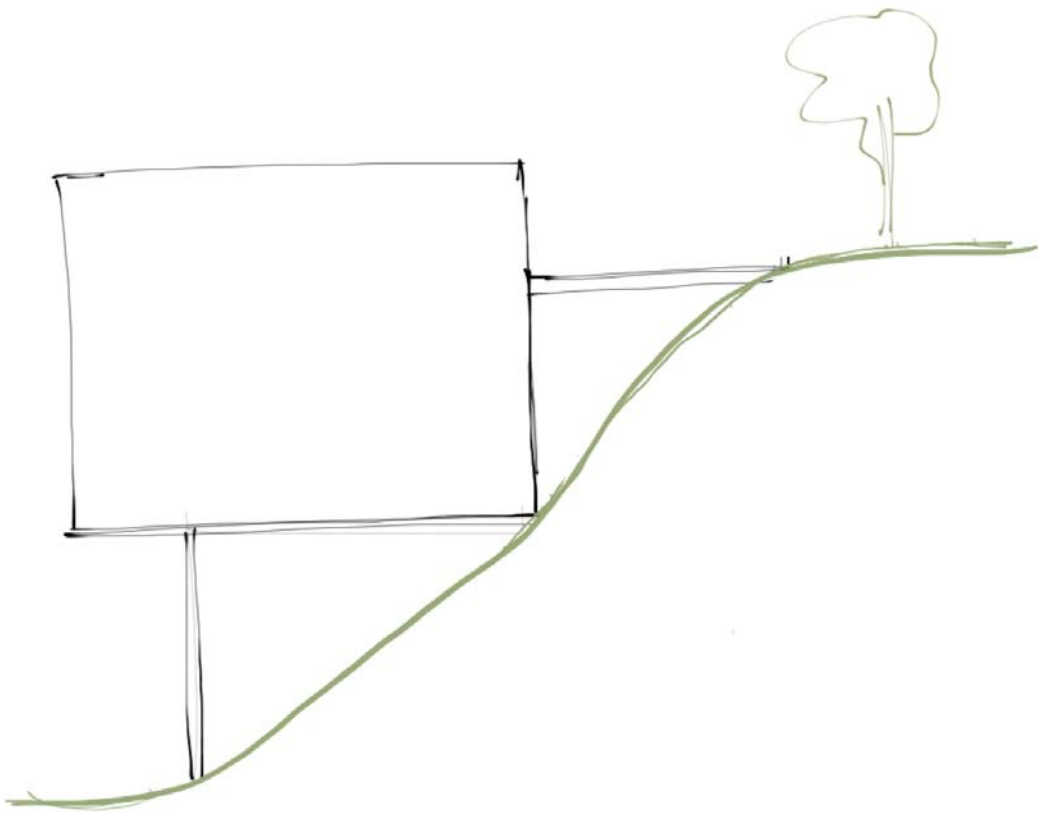

área-objeto

01 . 02 . **03** . 04 . 05 . 06 . 07

química . ana laura

elevação oeste

sistema expositivo móvel

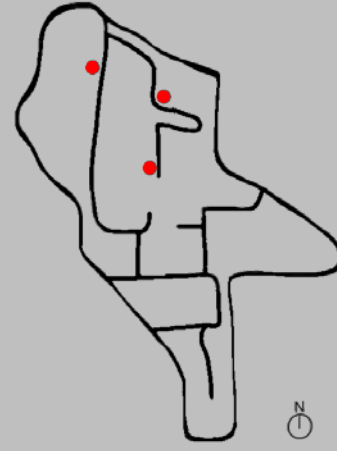
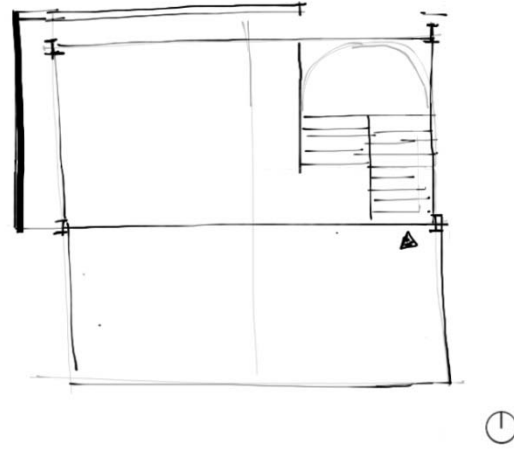
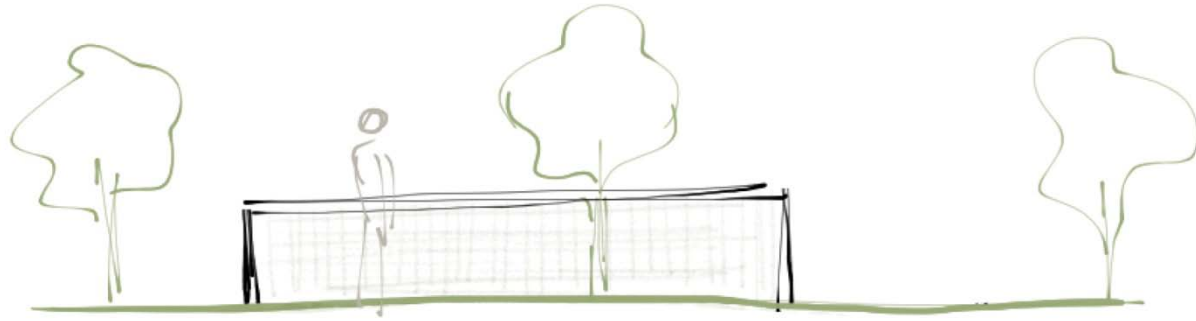

área-objeto

01 . 02 . **03** . 04 . 05 . 06 . 07

química . ana laura

elevação sul

sistema expositivo móvel

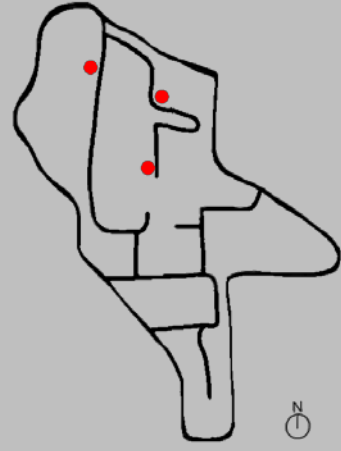
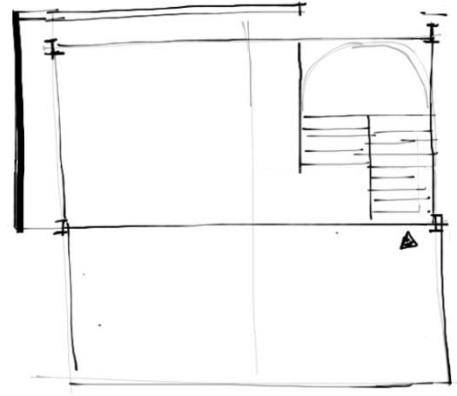
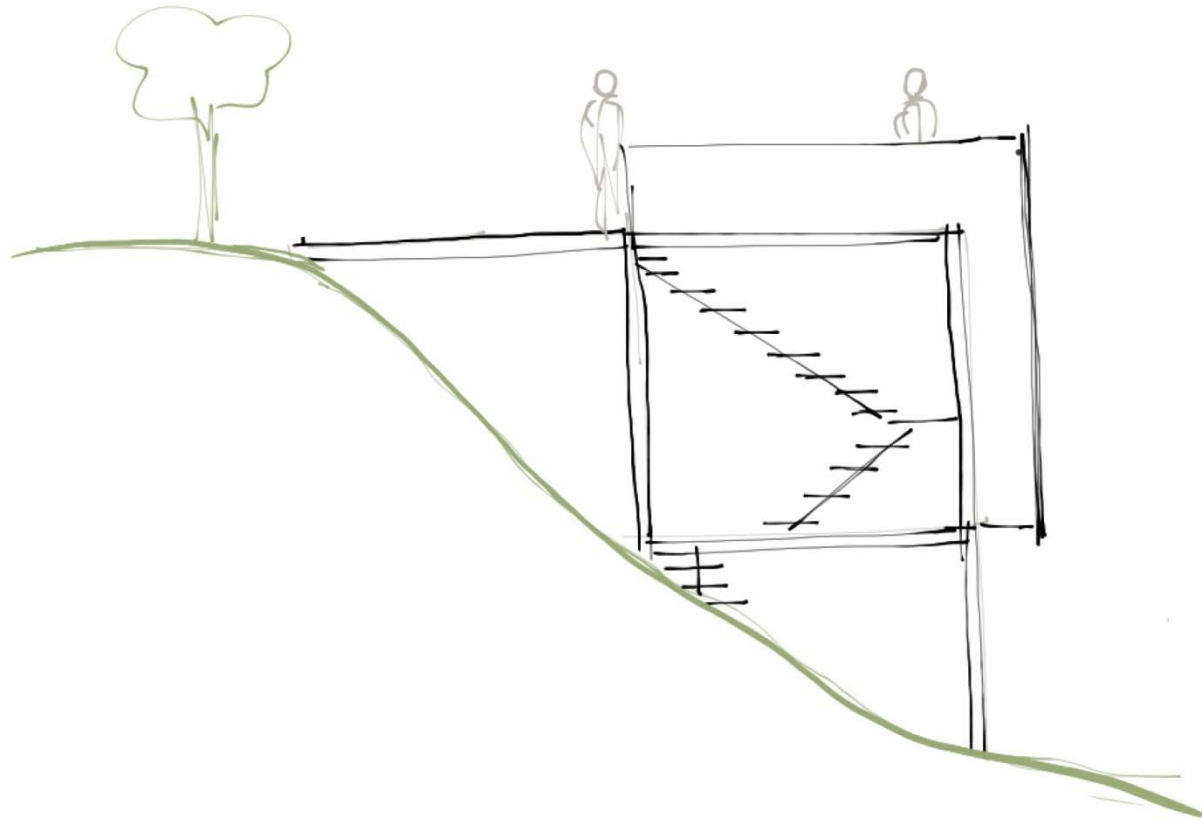

área-objeto

01 . 02 . **03** . 04 . 05 . 06 . 07

química . ana laura

elevação leste

sistema expositivo móvel

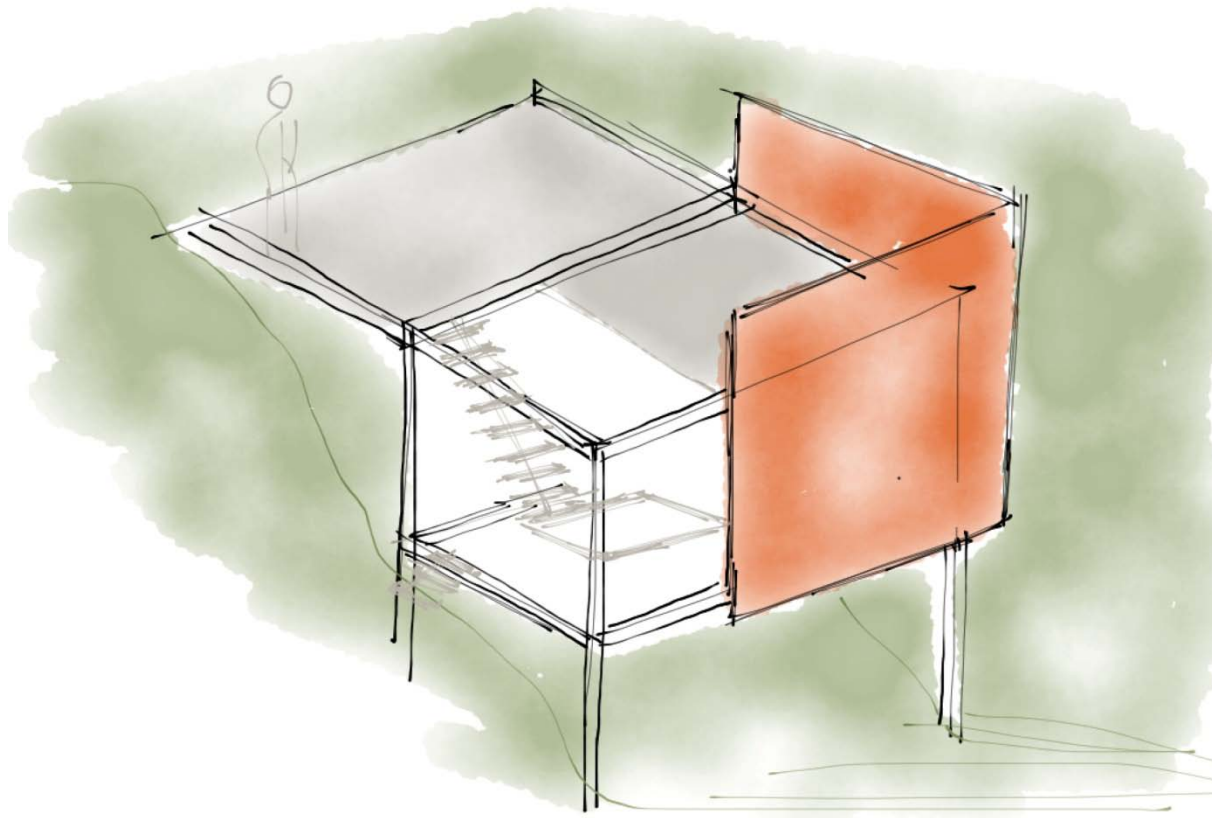

área-objeto

01 . 02 . **03** . 04 . 05 . 06 . 07

química . ana laura

perspectiva

sistema expositivo móvel

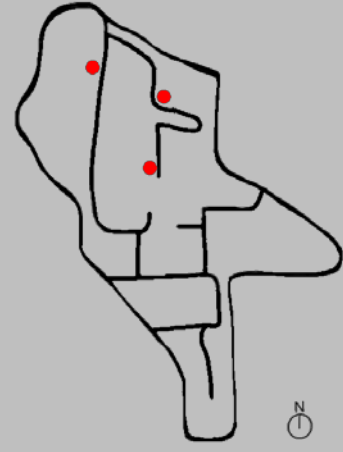
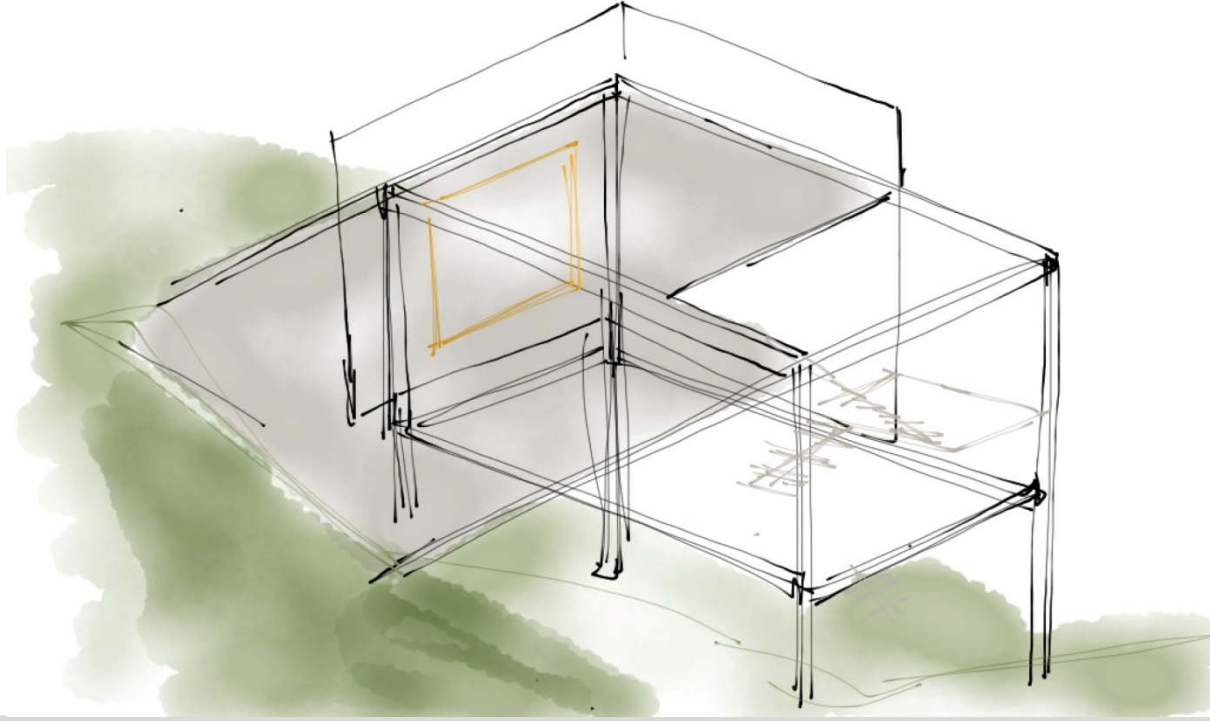

área-objeto

01 . 02 . **03** . 04 . 05 . 06 . 07

química . ana laura

perspectiva

sistema expositivo móvel

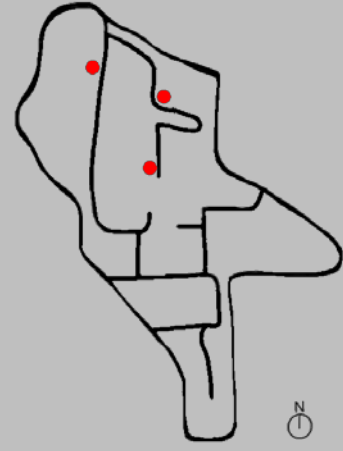
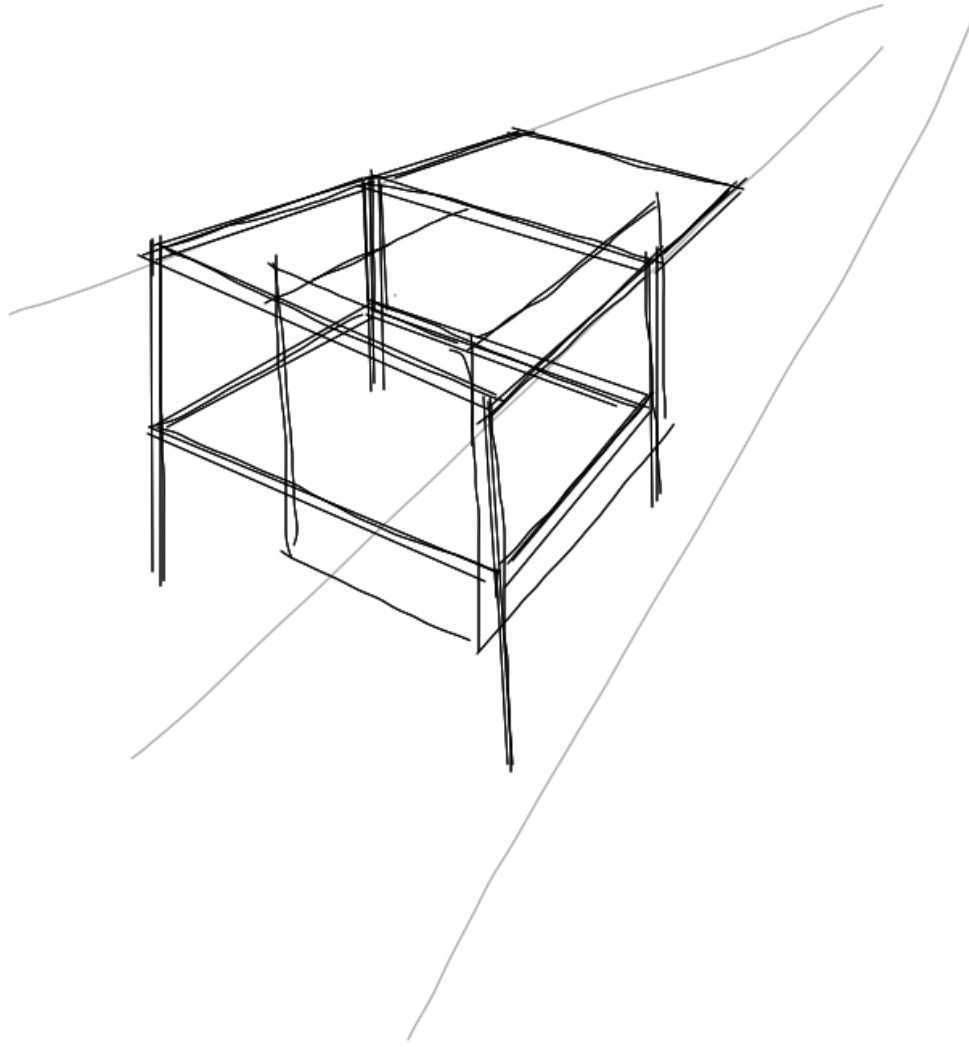

área-objeto

01 . 02 . **03** . 04 . 05 . 06 . 07

química . ana laura

perspectiva

sistema expositivo móvel

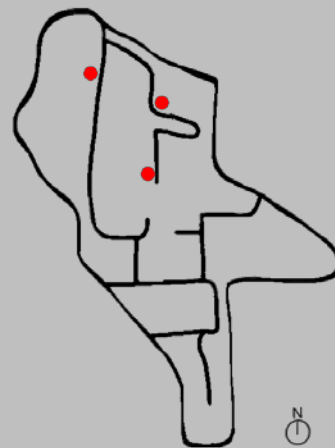
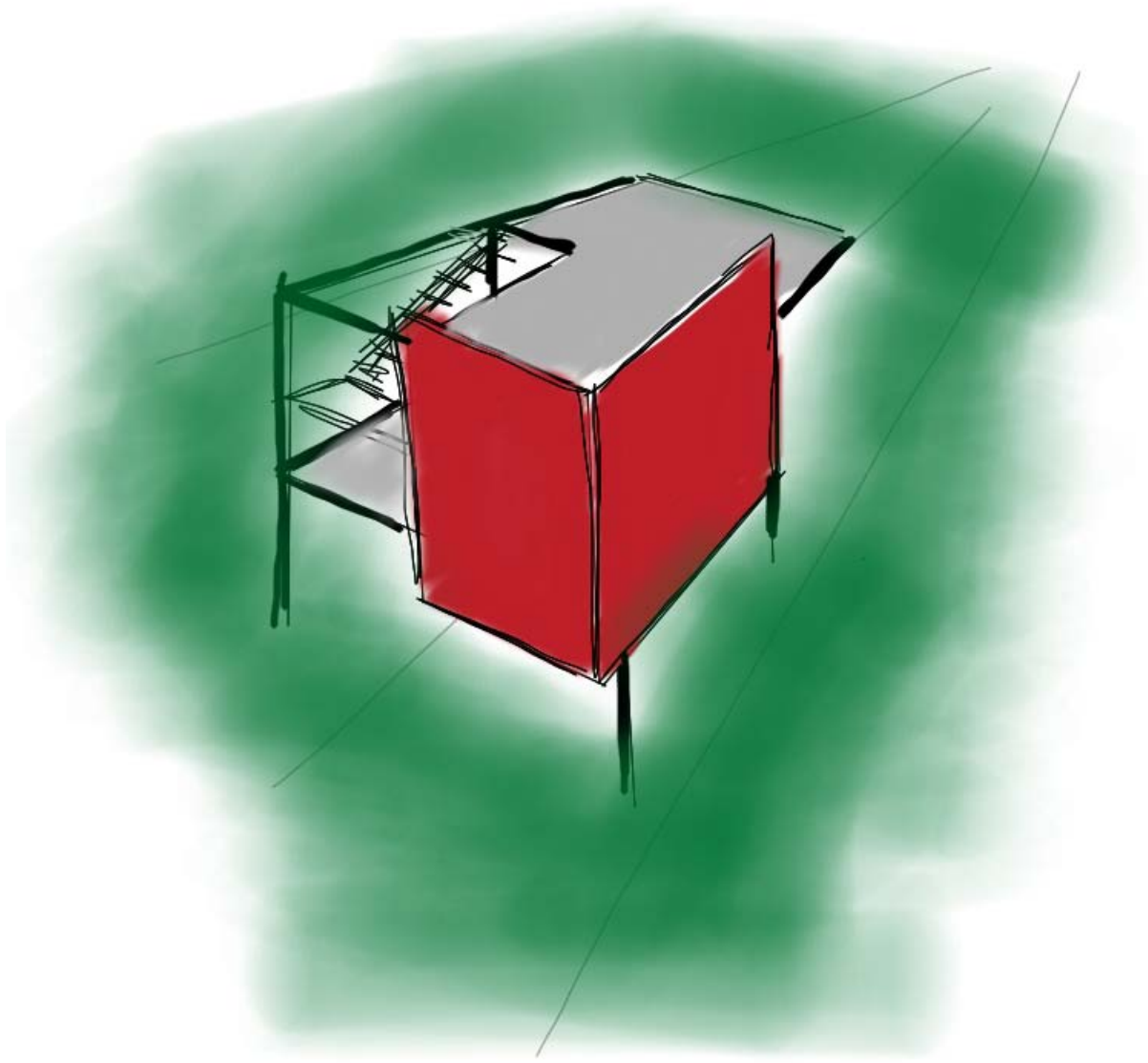

área-objeto

01 . 02 . **03** . 04 . 05 . 06 . 07

química . ana laura

perspectiva

sistema expositivo móvel

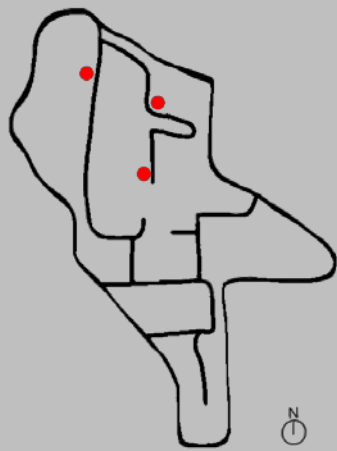
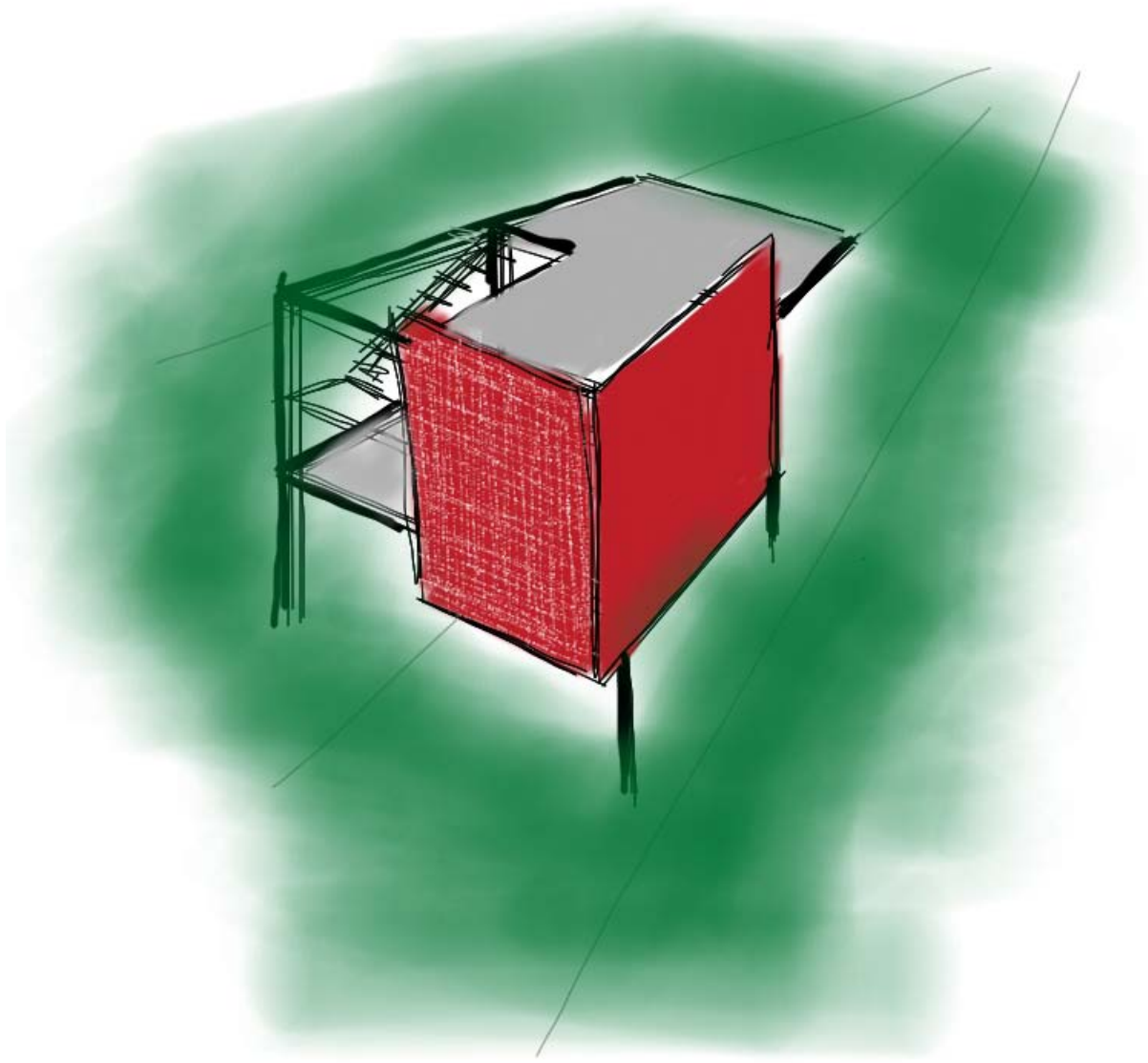

área-objeto

01 . 02 . **03** . 04 . 05 . 06 . 07

química . ana laura

perspectiva

sistema expositivo móvel



área-objeto

01 . 02 . **03** . 04 . 05 . 06 . 07

química . ana laura

montagem

sistema expositivo móvel

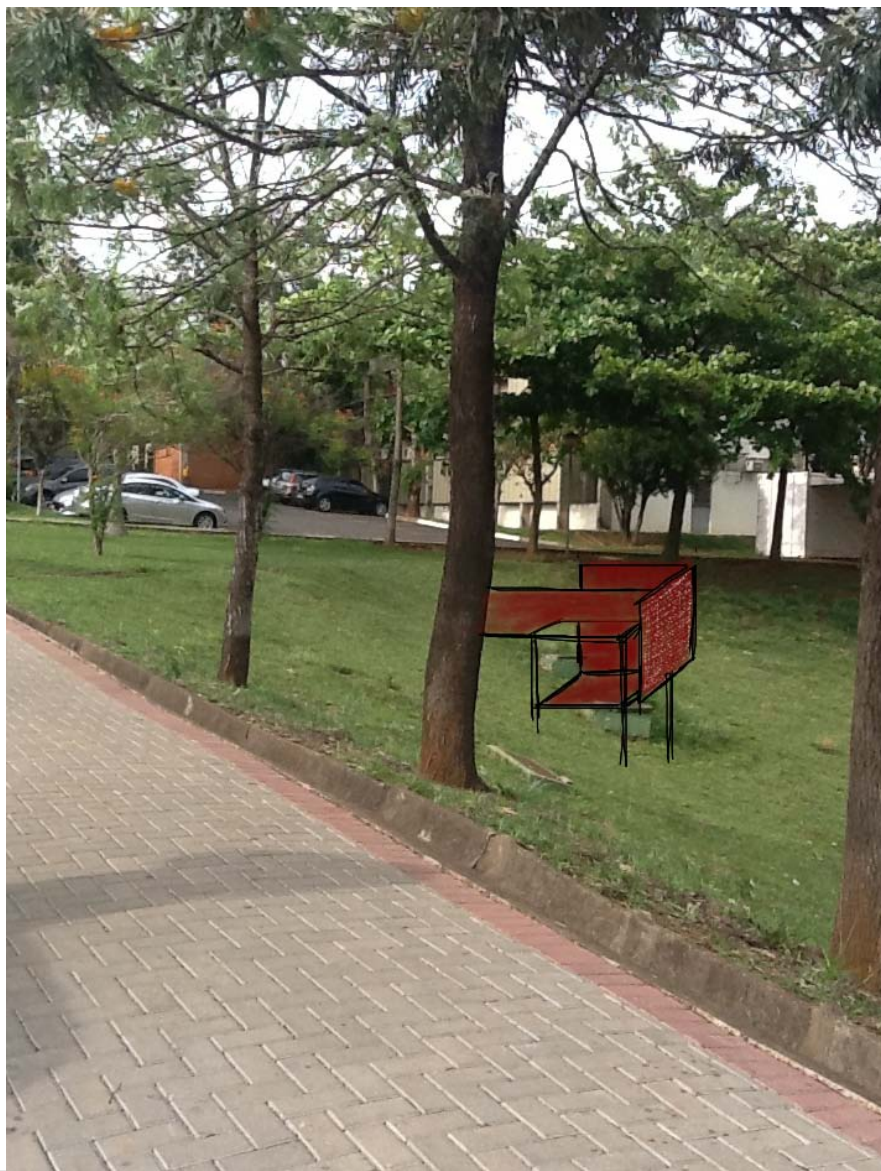

área-objeto

01 . 02 . **03** . 04 . 05 . 06 . 07

química . ana laura

montagem

sistema expositivo móvel

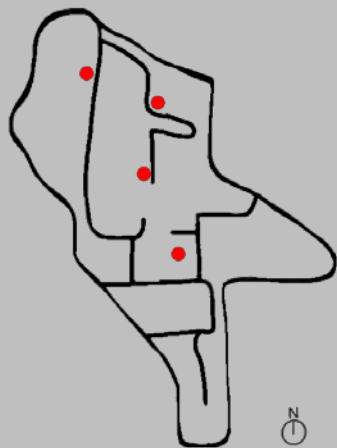
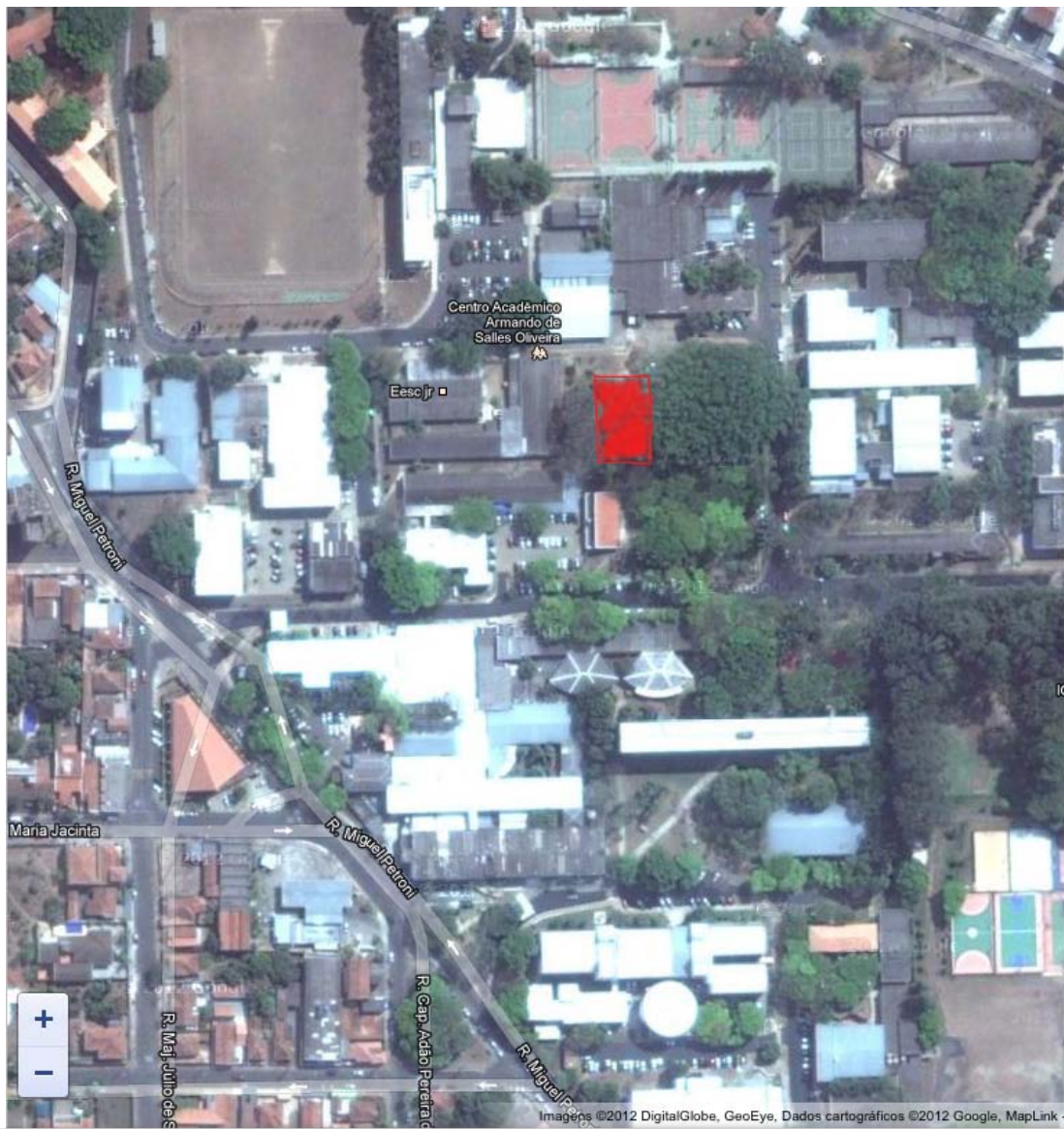

área-objeto

01 . 02 . 03 . **04** . 05 . 06 . 07

praça caaso . isabelle

implantação

sistema expositivo móvel

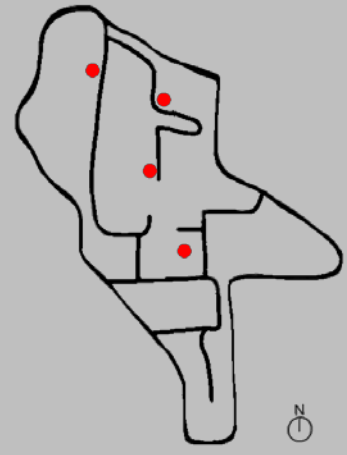
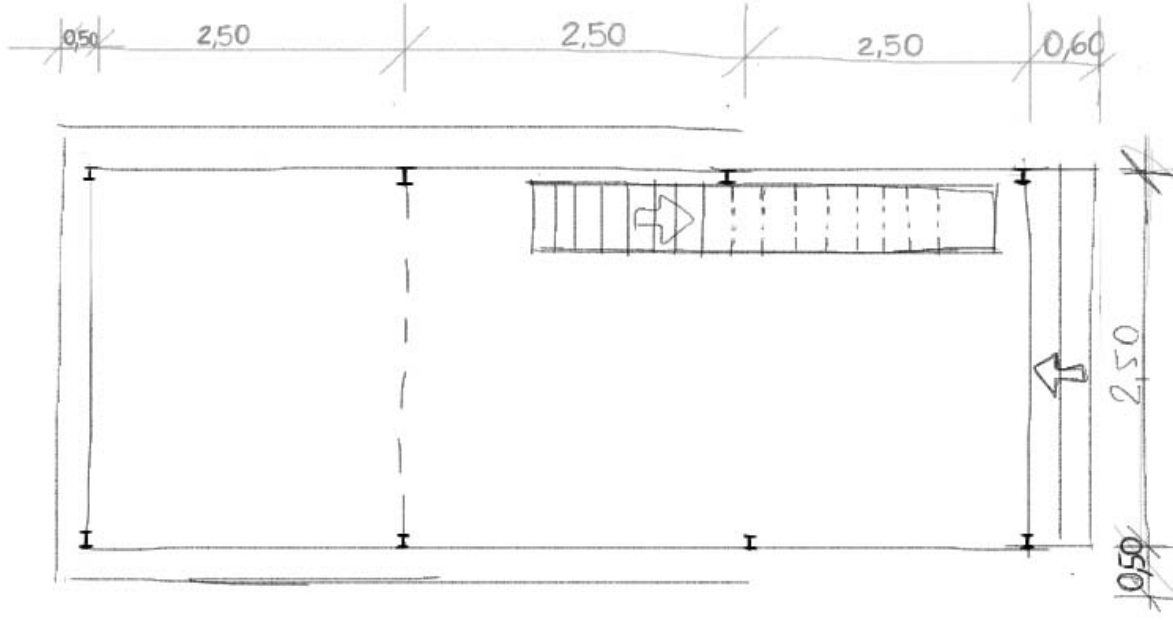

área-objeto

01 . 02 . 03 . **04** . 05 . 06 . 07

praça caaso . isabelle

planta baixa

sistema expositivo móvel

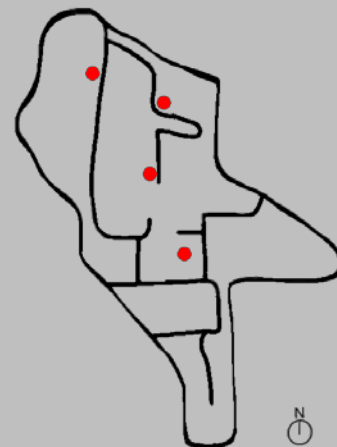
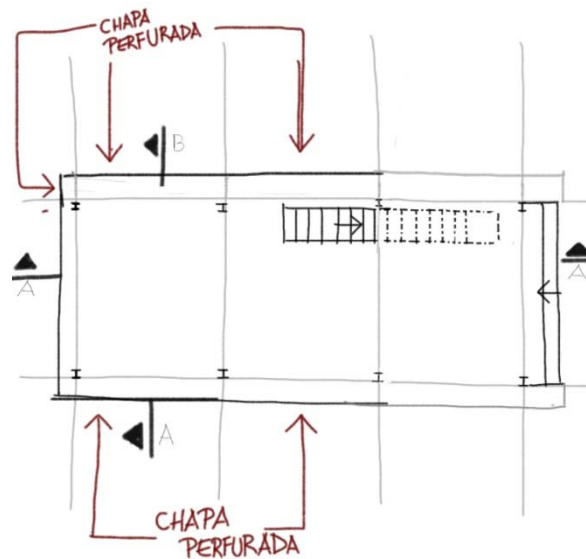
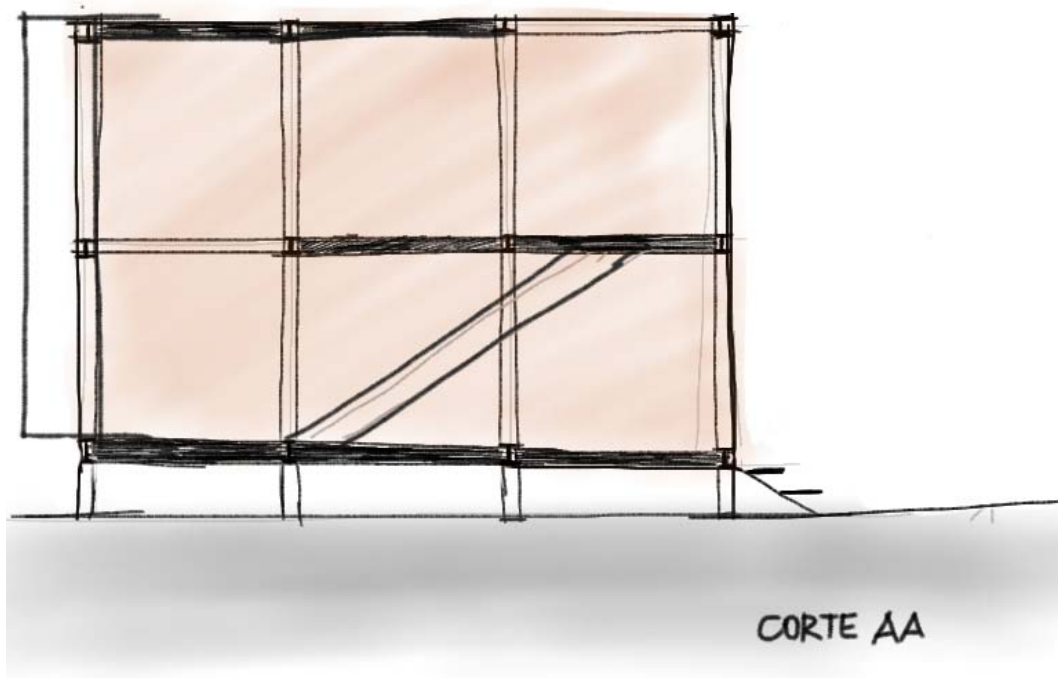

área-objeto

01 . 02 . 03 . **04** . 05 . 06 . 07

praça caaso . isabelle

cutte A-A

sistema expositivo móvel

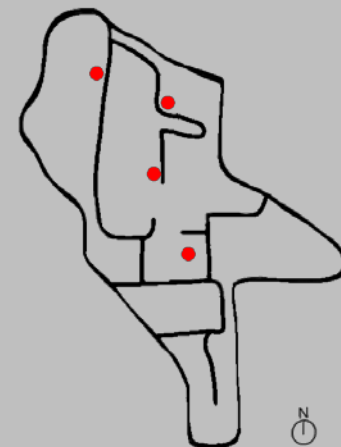
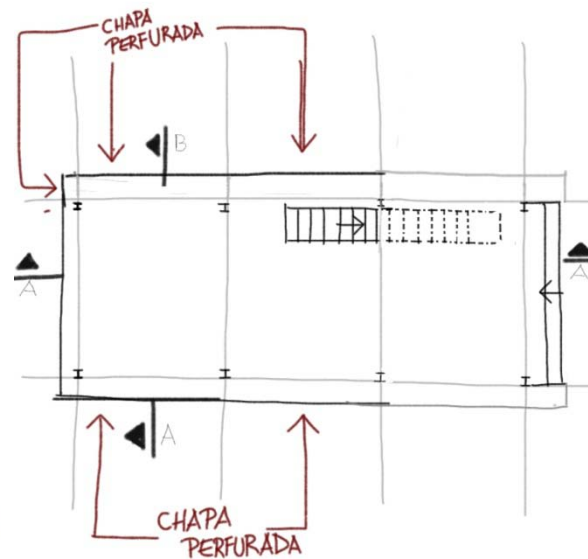
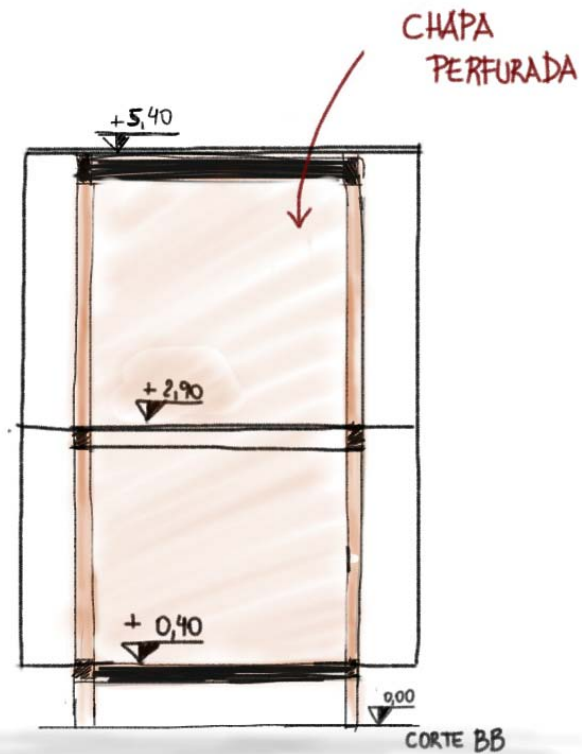

área-objeto

01 . 02 . 03 . **04** . 05 . 06 . 07

praça caaso . isabelle

corde B-B

sistema expositivo móvel

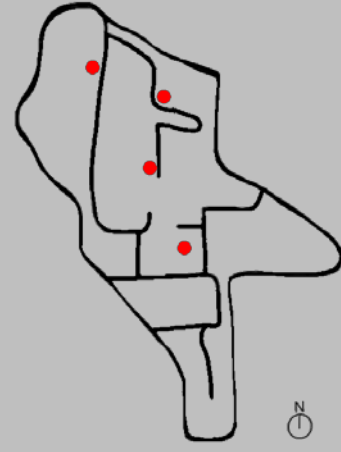
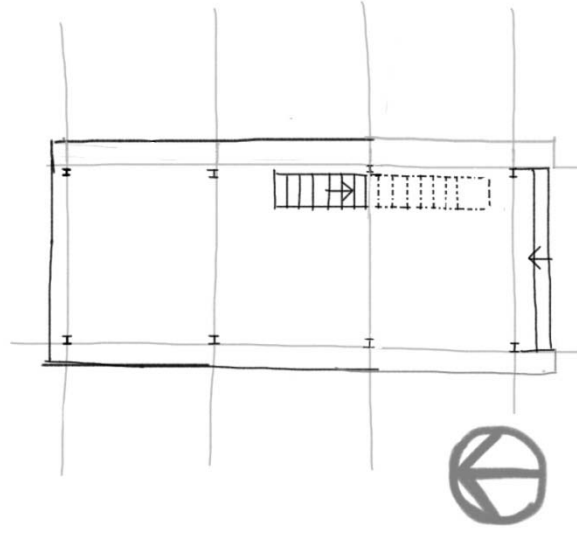
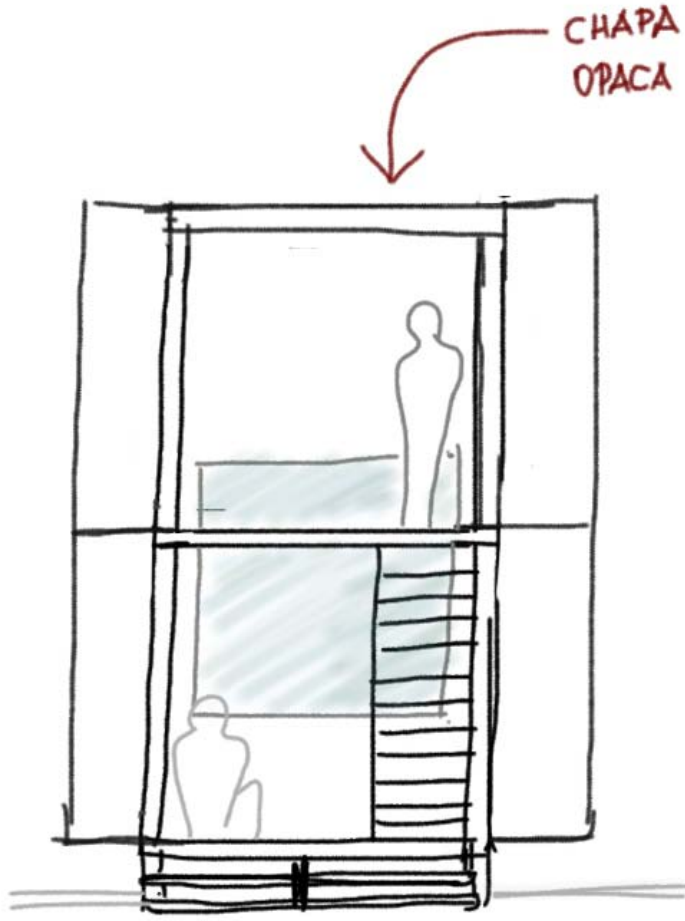

área-objeto

01 . 02 . 03 . **04** . 05 . 06 . 07

praça caaso . isabelle

vista frontal

sistema expositivo móvel

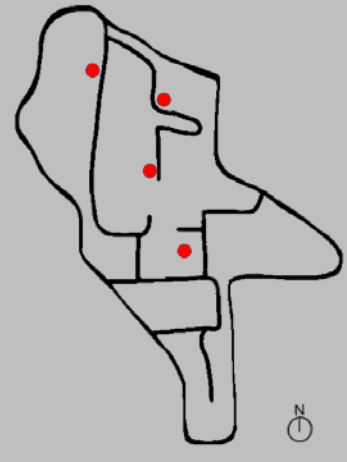
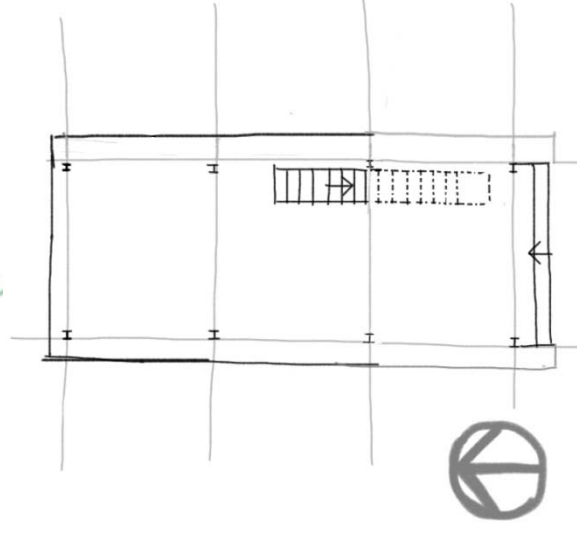
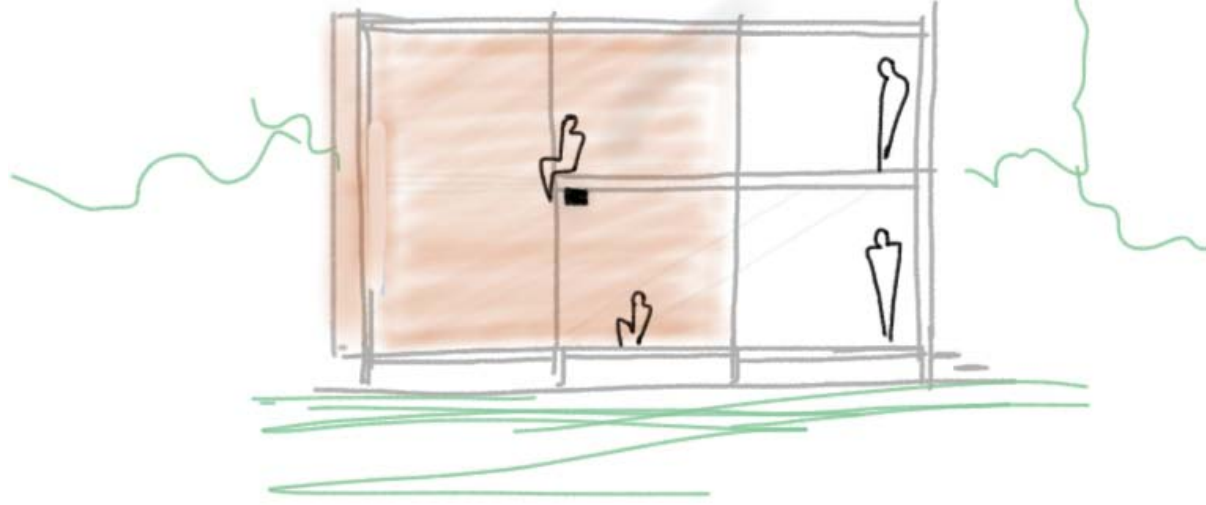

área-objeto

01 . 02 . 03 . **04** . 05 . 06 . 07

praça caaso . isabelle

vista lateral

sistema expositivo móvel

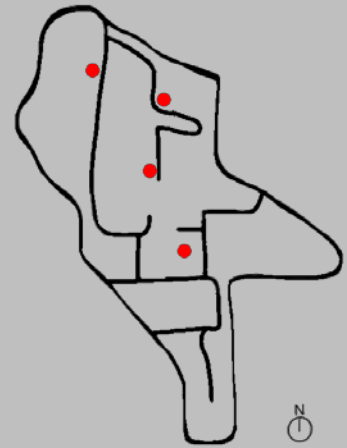
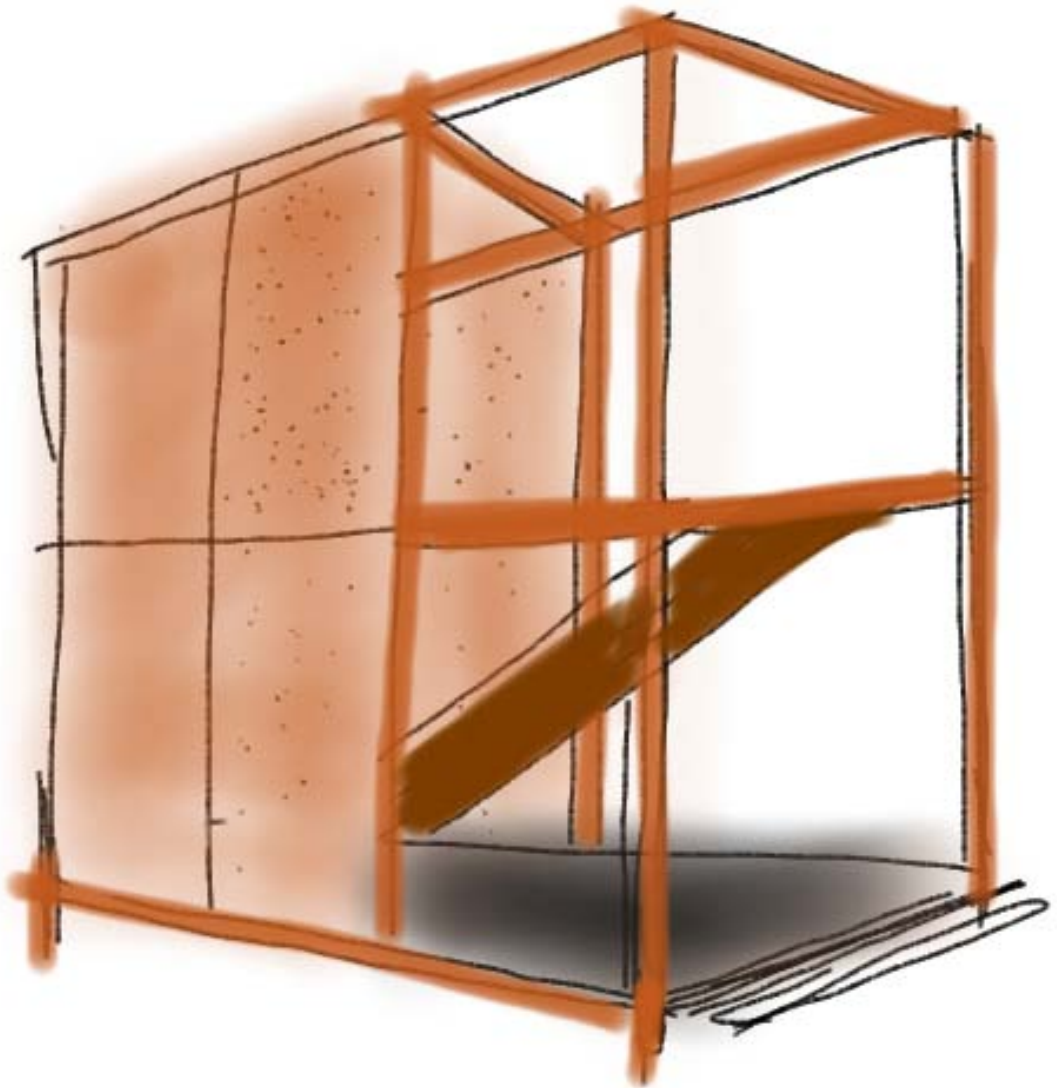

área-objeto

01 . 02 . 03 . **04** . 05 . 06 . 07

praça caaso . isabelle

perspetiva

sistema expositivo móvel

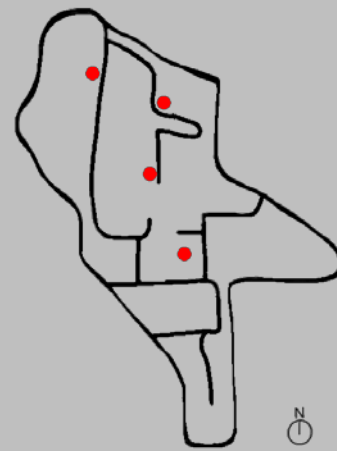
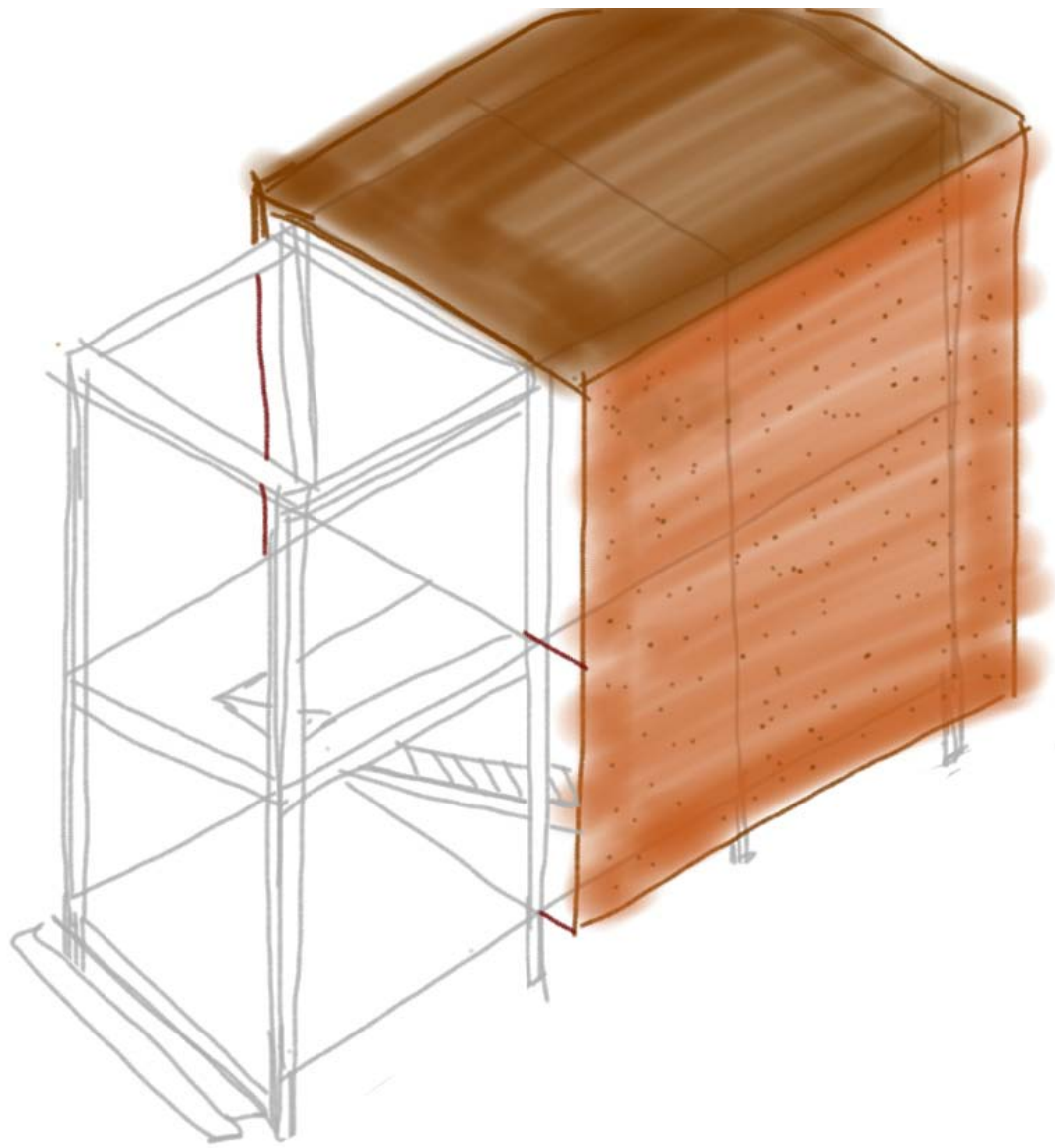

área-objeto

01 . 02 . 03 . **04** . 05 . 06 . 07

praça caaso . isabelle

perspectiva isométrica

sistema expositivo móvel

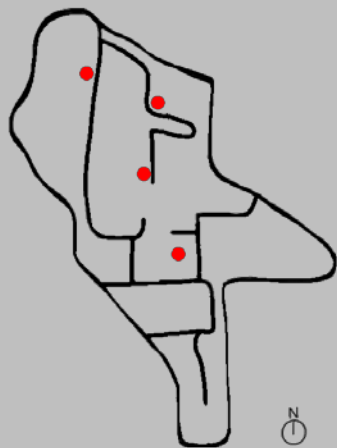

área-objeto

01 . 02 . 03 . **04** . 05 . 06 . 07

praça caaso . isabelle

perspectiva isométrica

sistema expositivo móvel



área-objeto

01 . 02 . 03 . 04 . **05** . 06 . 07

icmc . renata
implantação

sistema expositivo móvel

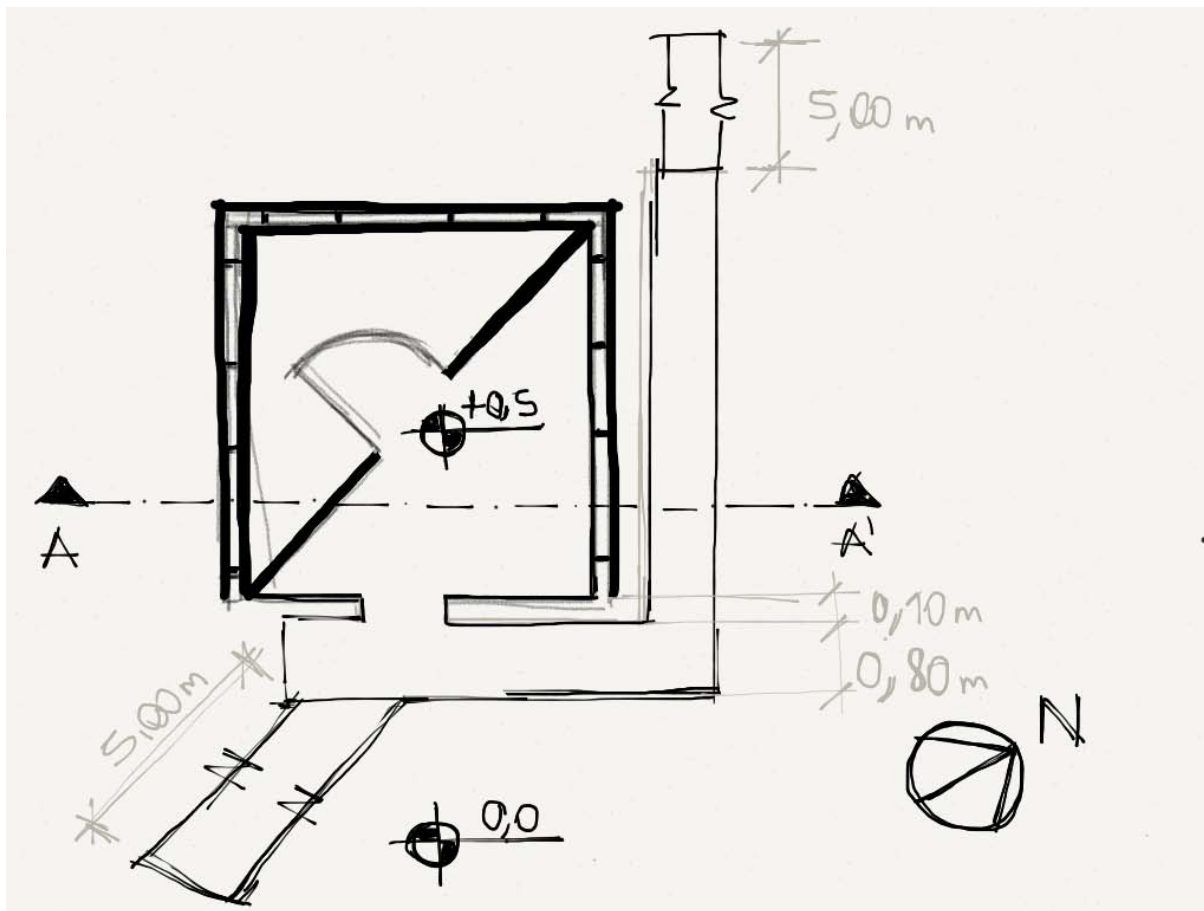

área-objeto

01 . 02 . 03 . 04 . **05** . 06 . 07

icmc . renata

planta baixa

sistema expositivo móvel

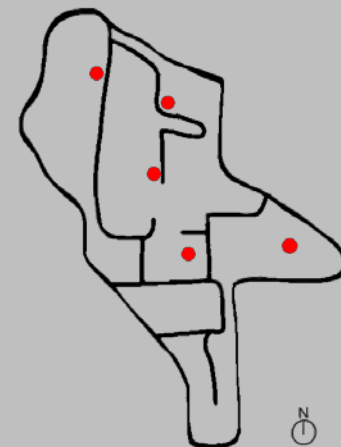
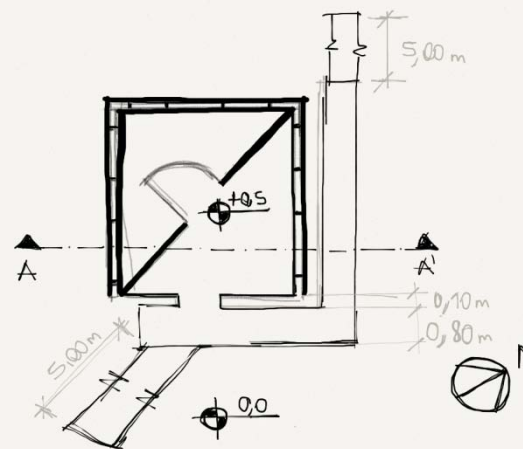
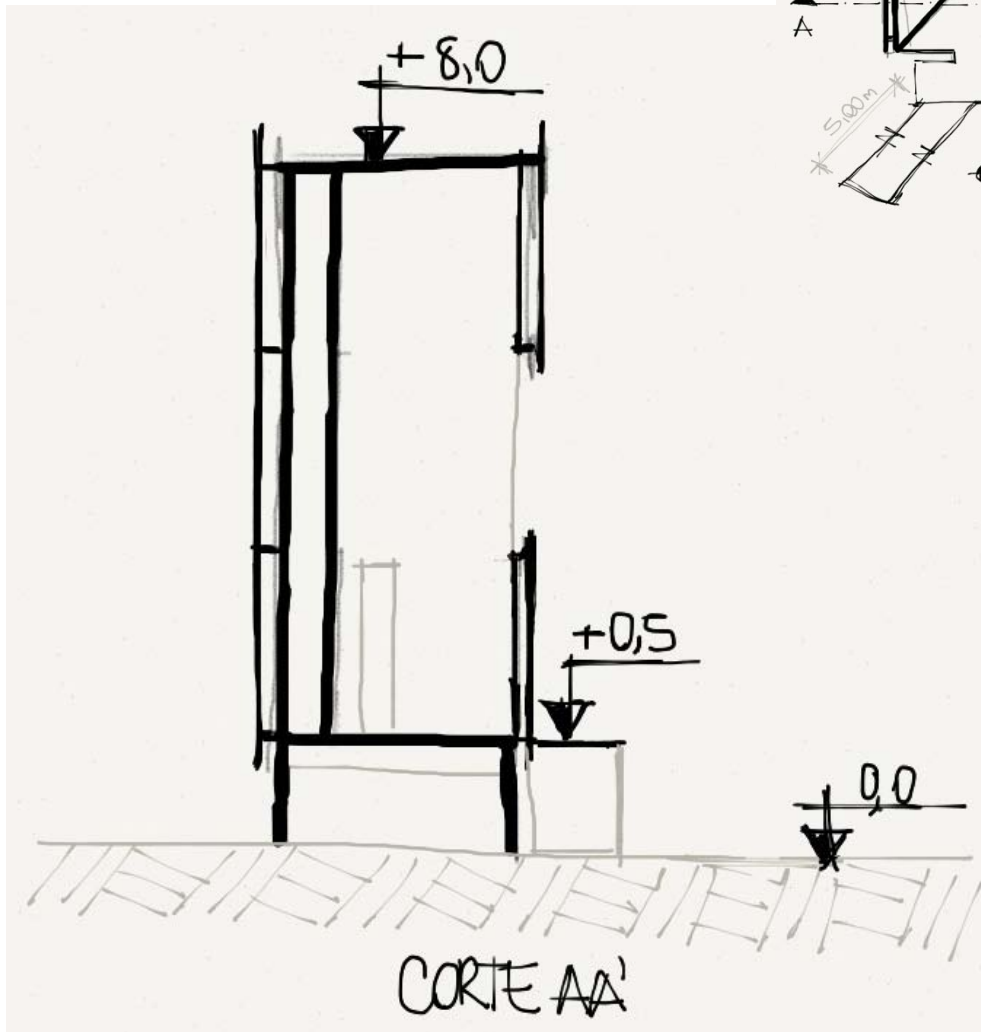

área-objeto
01 . 02 . 03 . 04 . **05** . 06 . 07

icmc . renata
corte A-A

sistema expositivo móvel

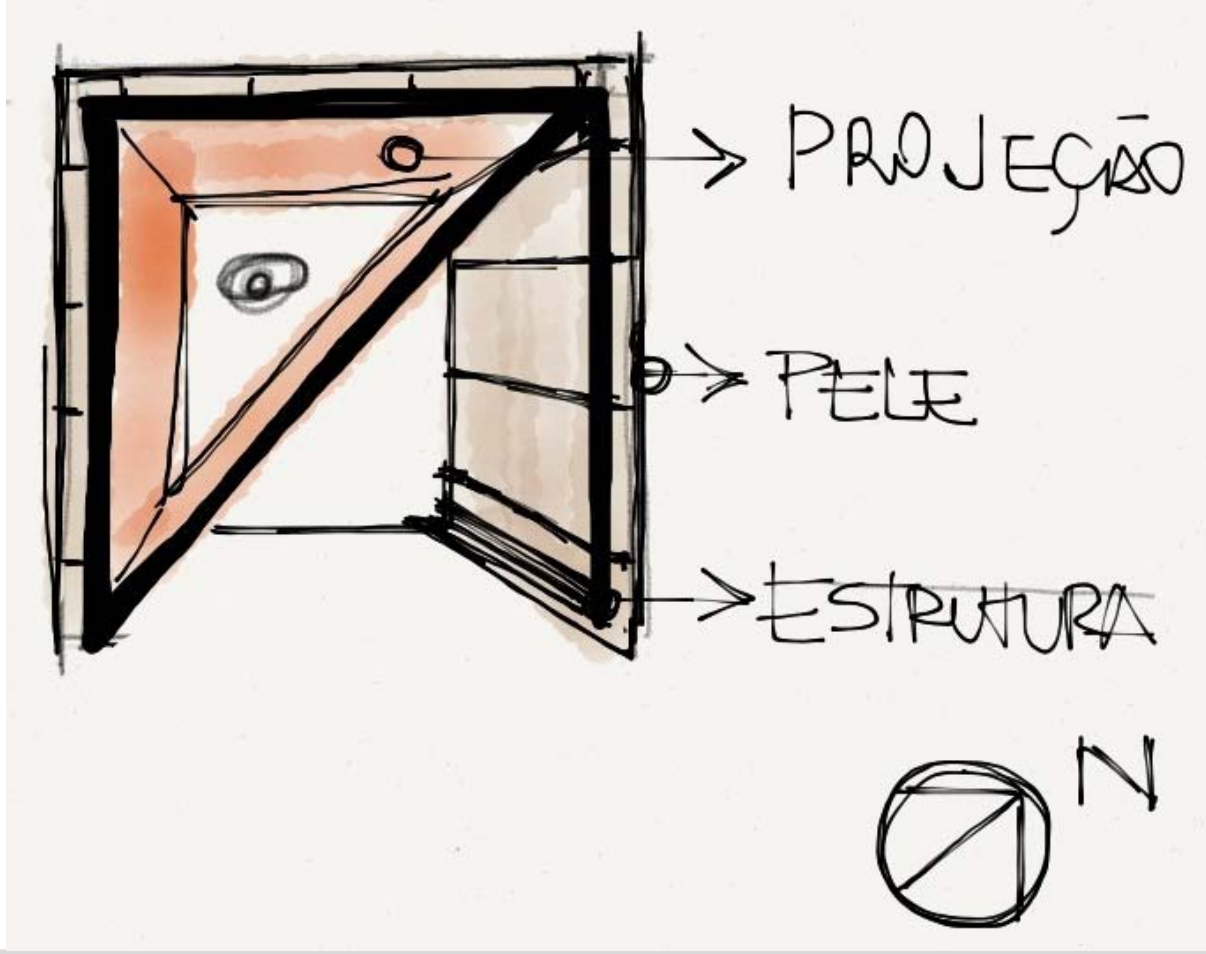

área-objeto

01 . 02 . 03 . 04 . **05** . 06 . 07

icmc . renata

análise em planta do folie

sistema expositivo móvel

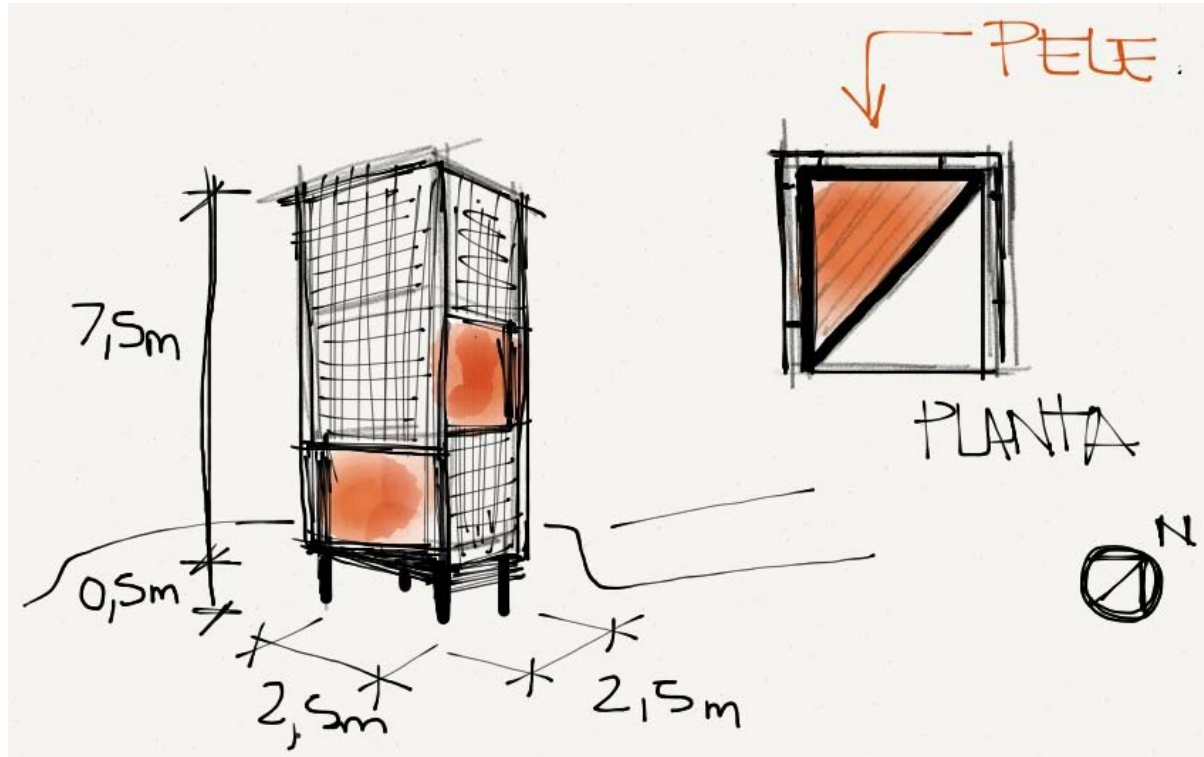

área-objeto

01 . 02 . 03 . 04 . **05** . 06 . 07

icmc . renata

perspectiva e cotas

sistema expositivo móvel

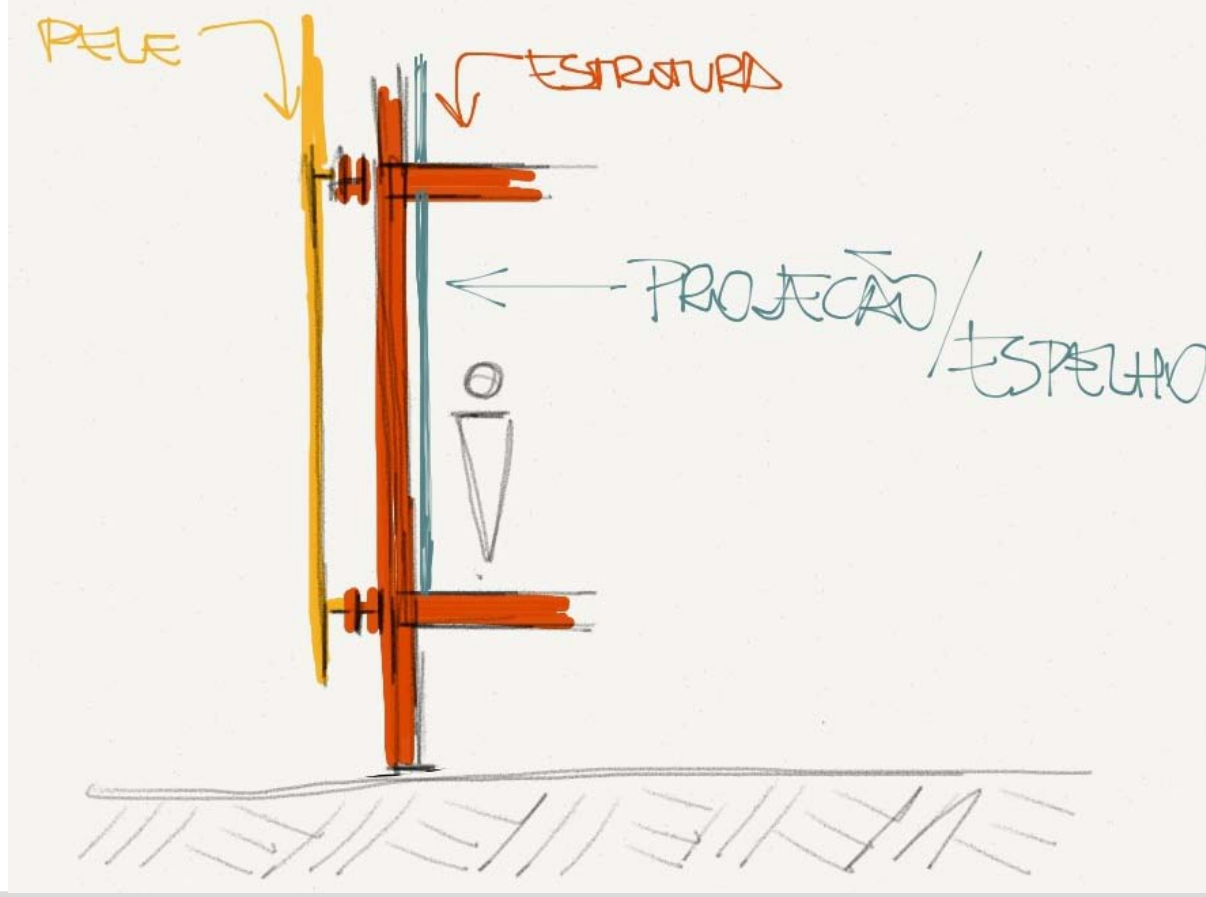

área-objeto

01 . 02 . 03 . 04 . **05** . 06 . 07

icmc . renata

croqui da articulação estrutura-pele

sistema expositivo móvel



área-objeto

01 . 02 . 03 . 04 . **05** . 06 . 07

icmc . renata

perspectiva e materialidade

sistema expositivo móvel

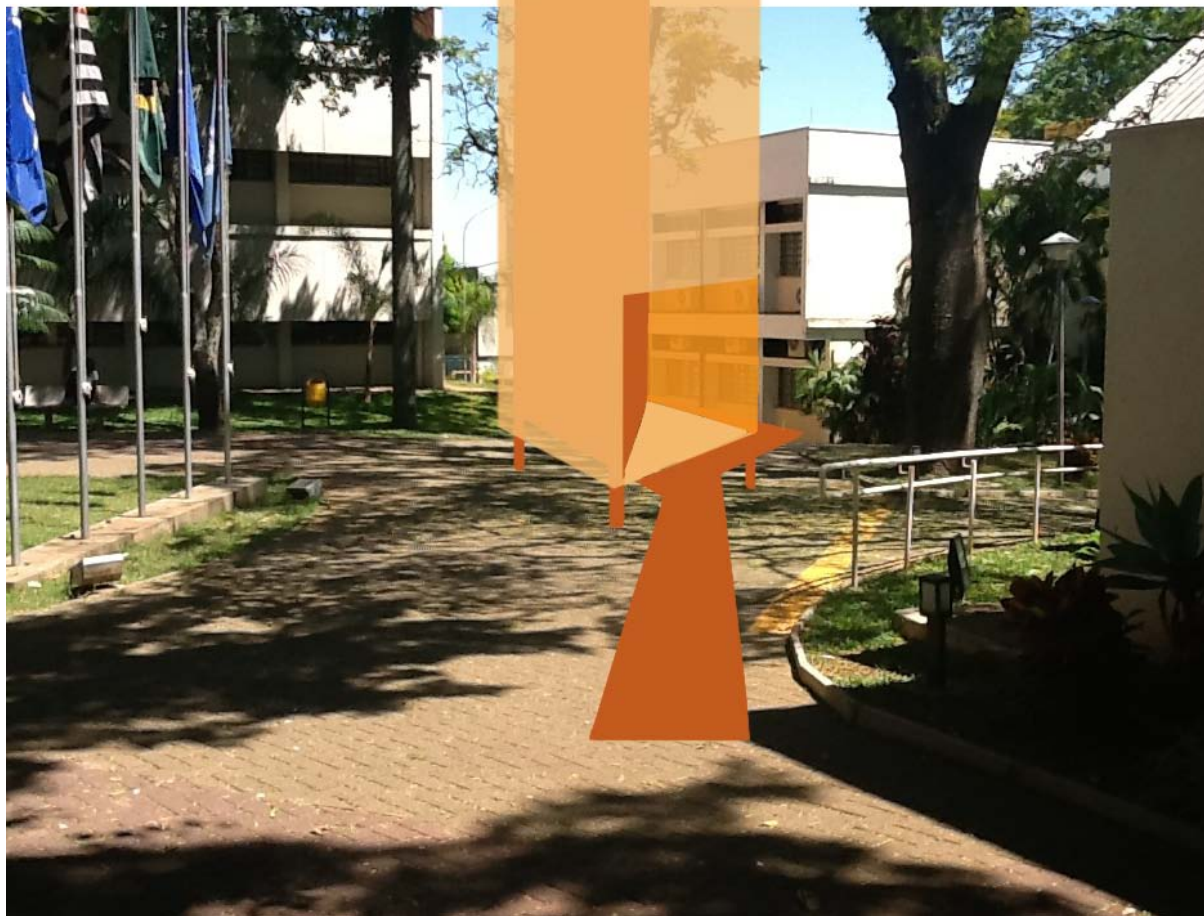

área-objeto

01 . 02 . 03 . 04 . **05** . 06 . 07

icmc . renata
montagem

sistema expositivo móvel



área-objeto

01 . 02 . 03 . 04 . 05 . **06** . 07

e1 . letícia
implantação

sistema expositivo móvel

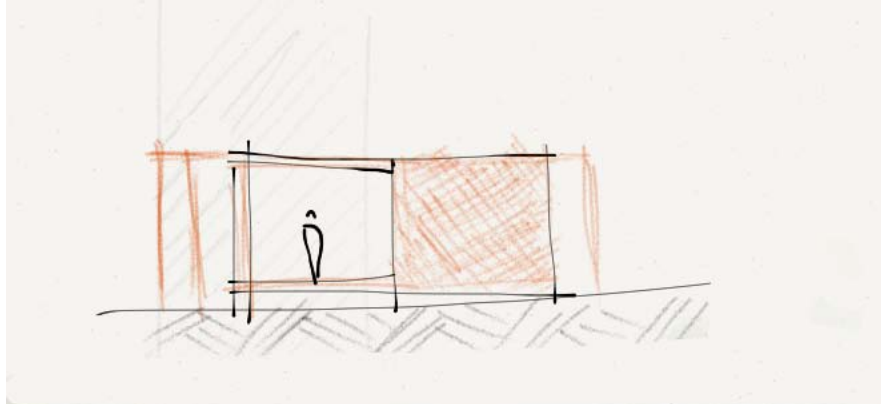
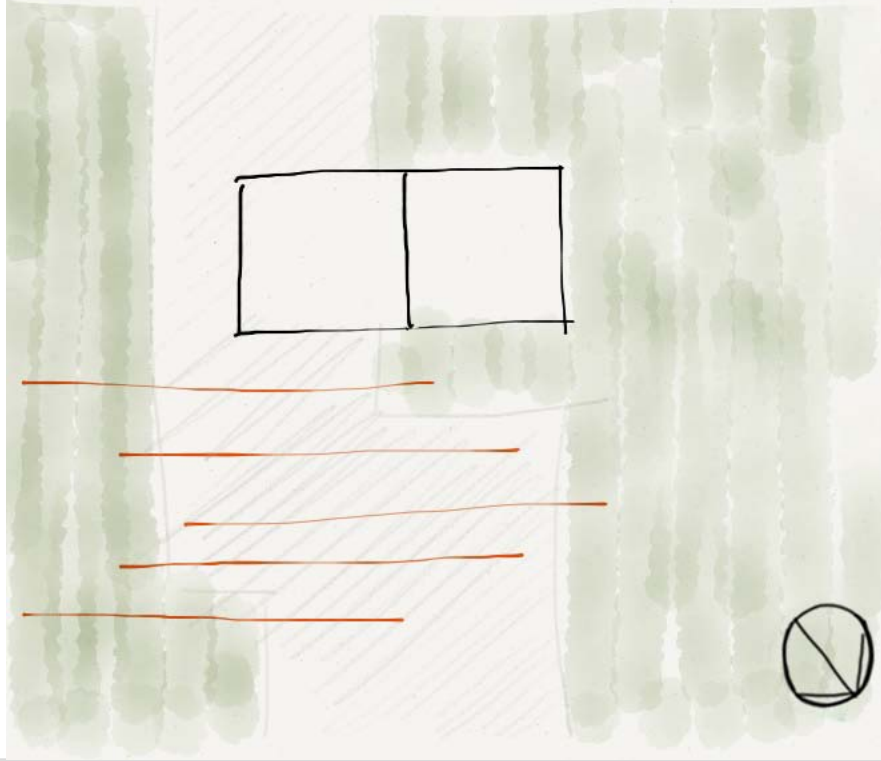

área-objeto

01 . 02 . 03 . 04 . 05 . **06** . 07

e1 . letícia
implantação

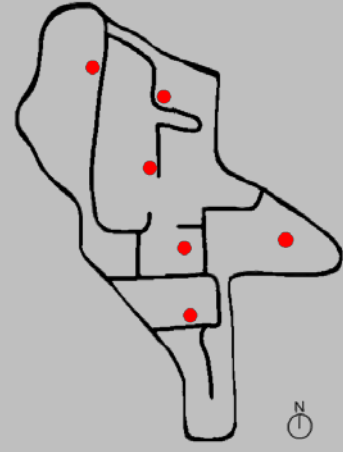

sistema expositivo móvel

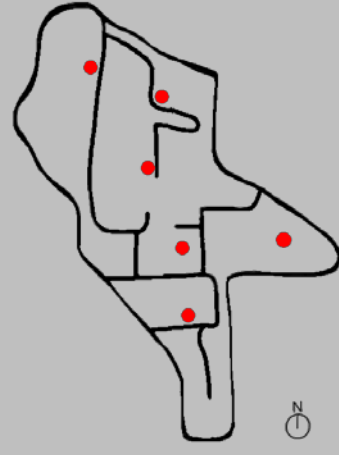
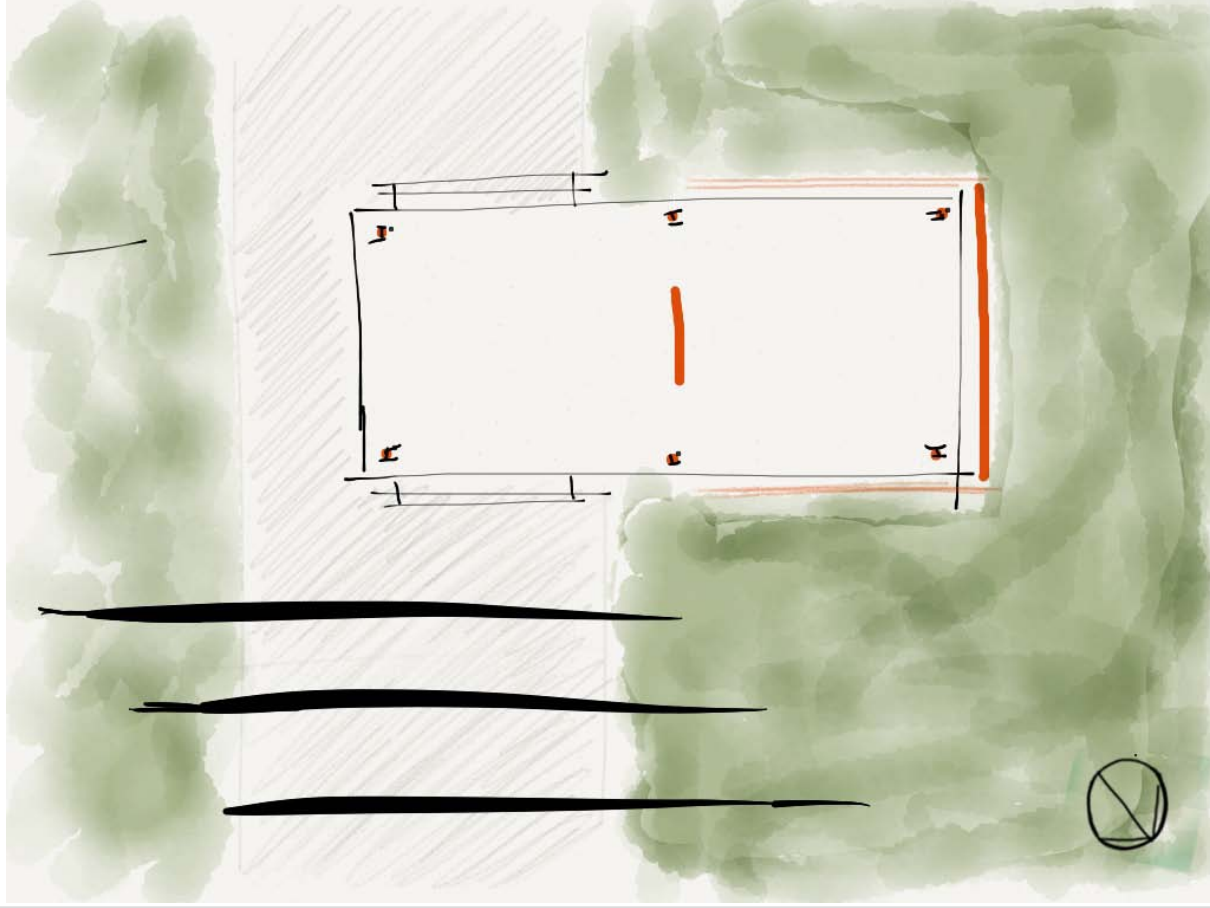

área-objeto

01 . 02 . 03 . 04 . 05 . **06** . 07

e1 . letícia
implantação

sistema expositivo móvel

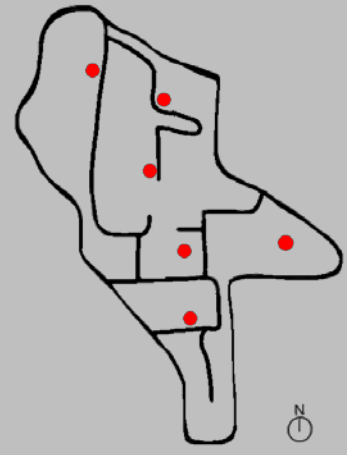
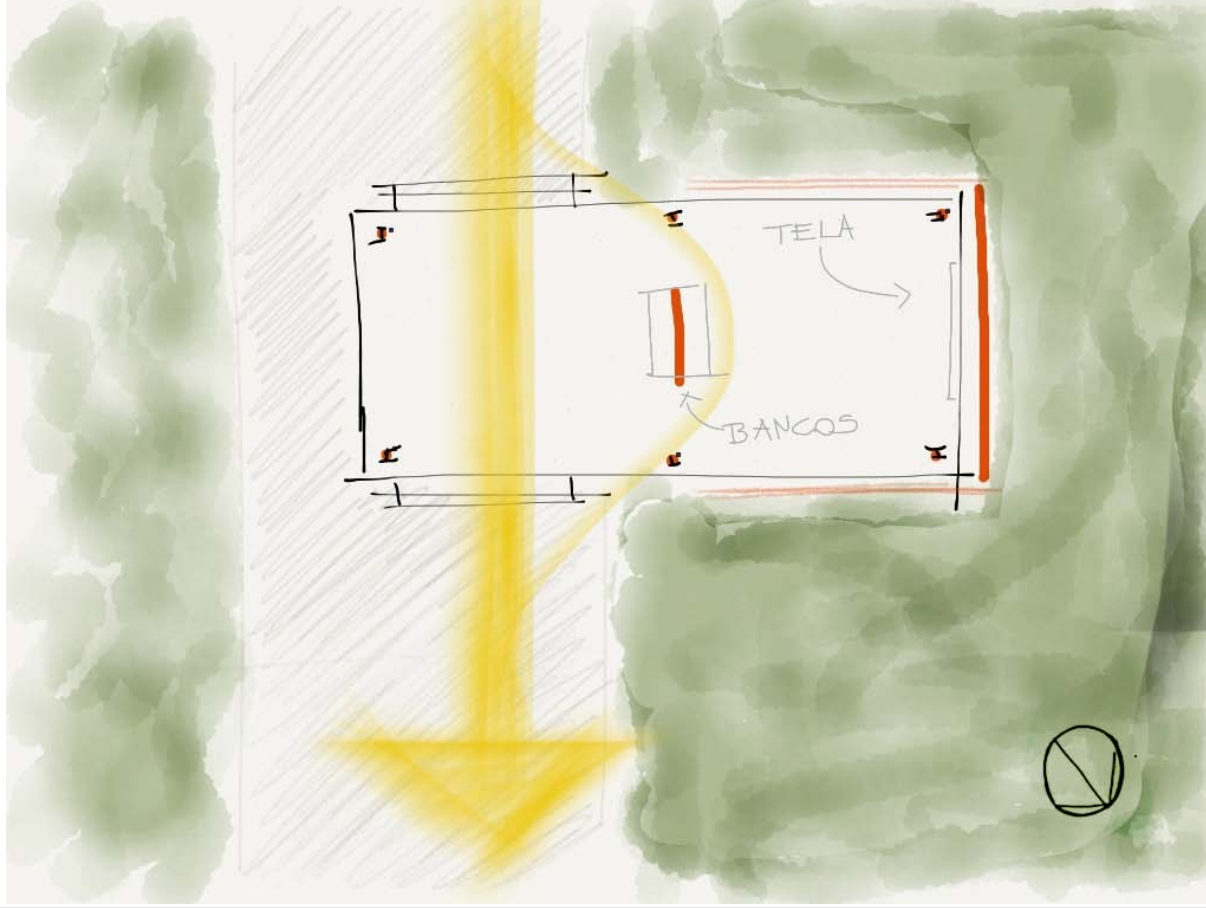

área-objeto

01 . 02 . 03 . 04 . 05 . **06** . 07

e1 . letícia

fluxo

sistema expositivo móvel

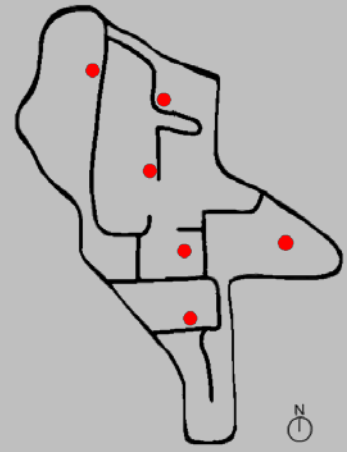
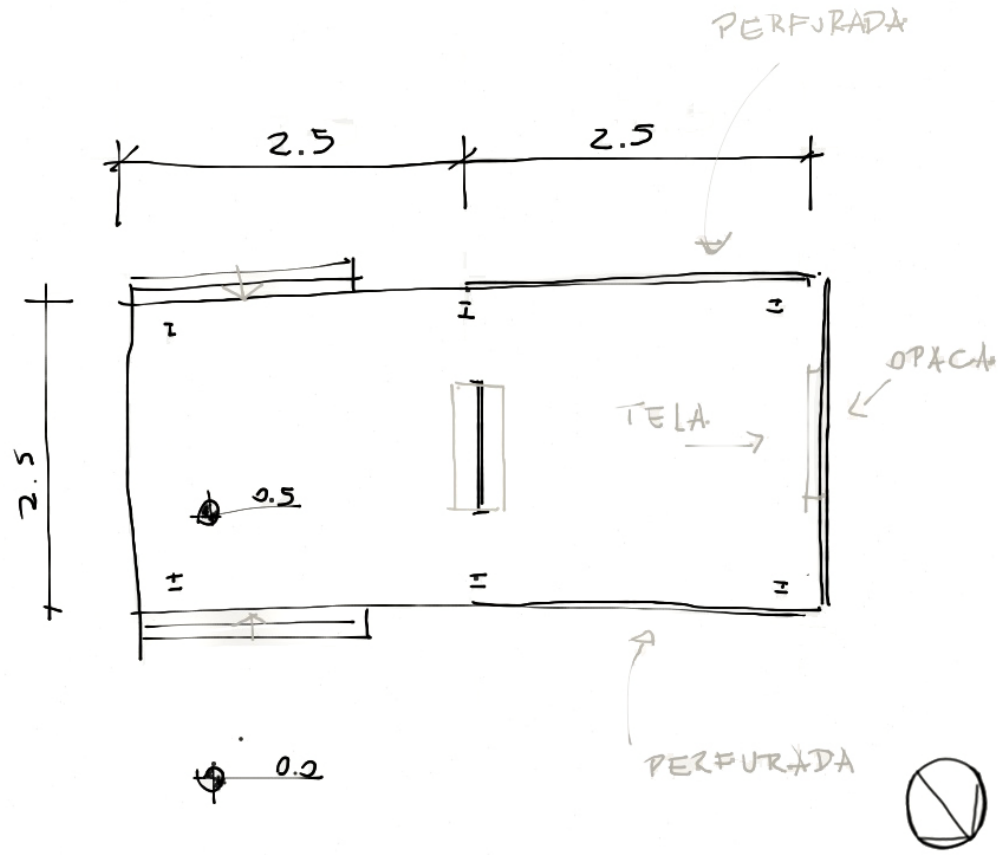

área-objeto

01 . 02 . 03 . 04 . 05 . 06 . 07

e1 . letícia

planta baixa

sistema expositivo móvel

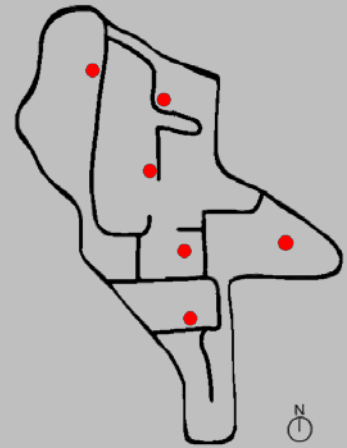
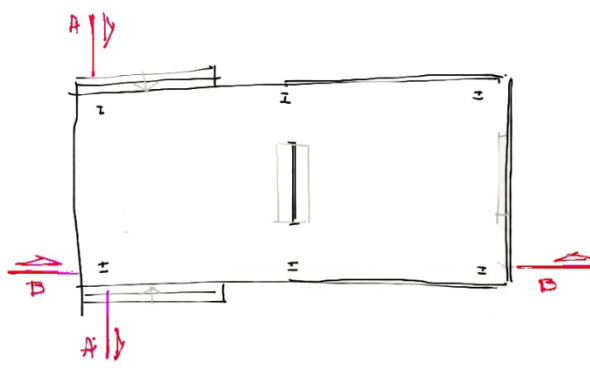
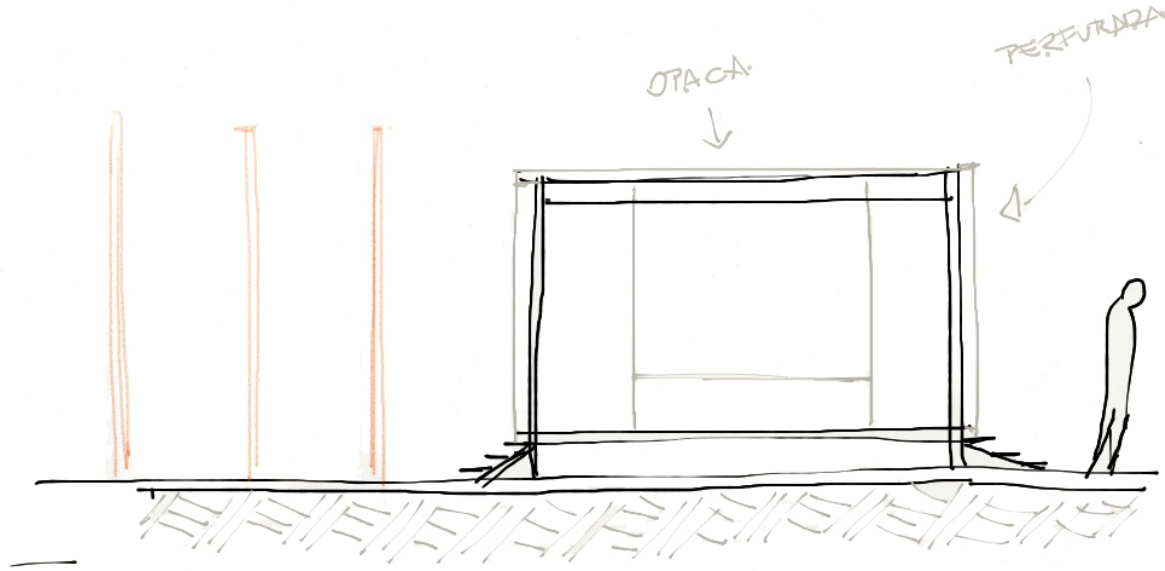

área-objeto

01 . 02 . 03 . 04 . 05 . **06** . 07

e1 . letícia

corte A-A

sistema expositivo móvel

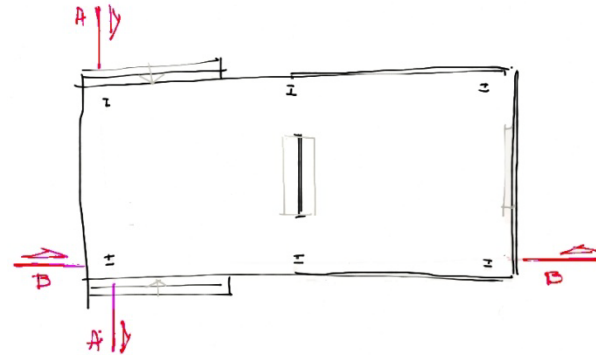
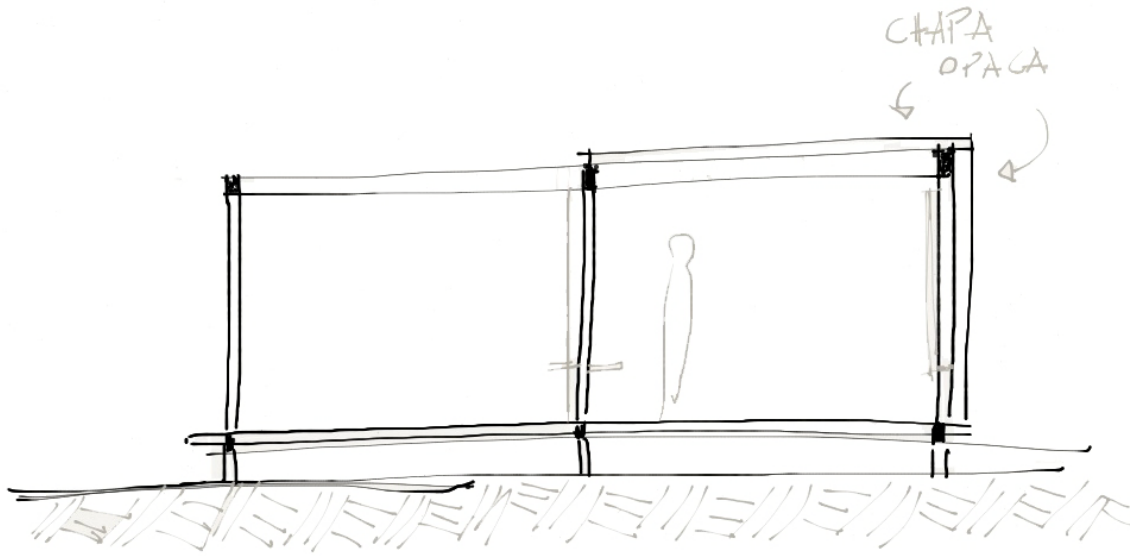

área-objeto

01 . 02 . 03 . 04 . 05 . **06** . 07

e1 . letícia

corte B-B

sistema expositivo móvel

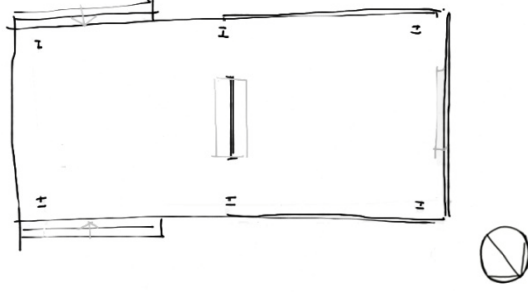
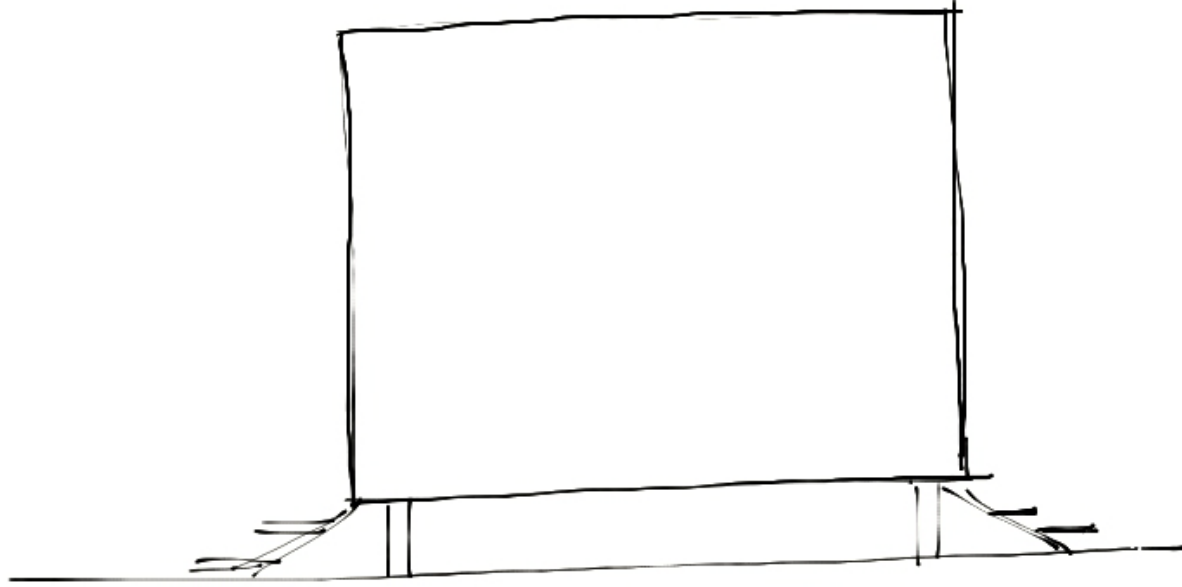

área-objeto

01 . 02 . 03 . 04 . 05 . **06** . 07

e1 . letícia

elevação noroeste

sistema expositivo móvel

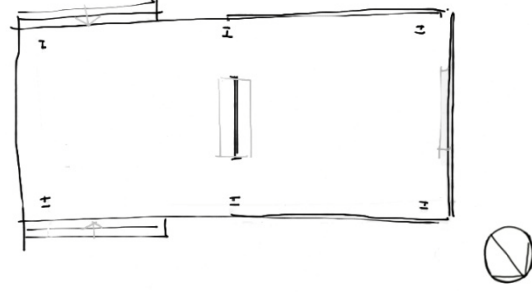
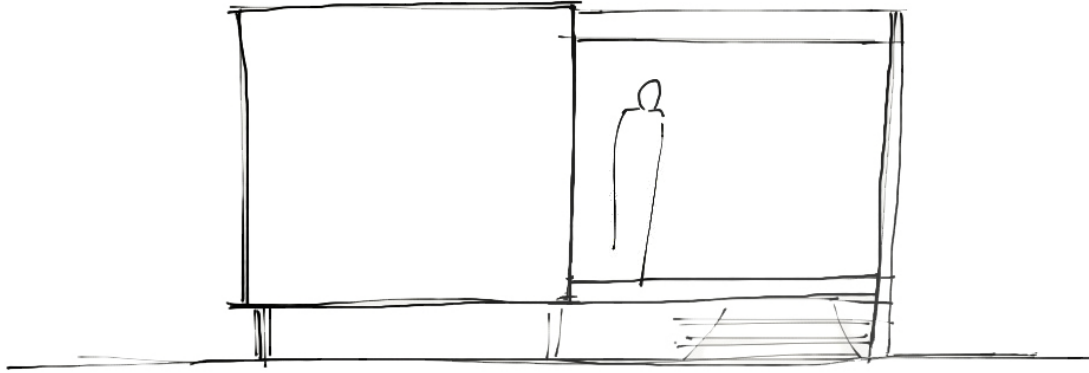

área-objeto

01 . 02 . 03 . 04 . 05 . **06** . 07

e1 . letícia

elevação sudoeste

sistema expositivo móvel

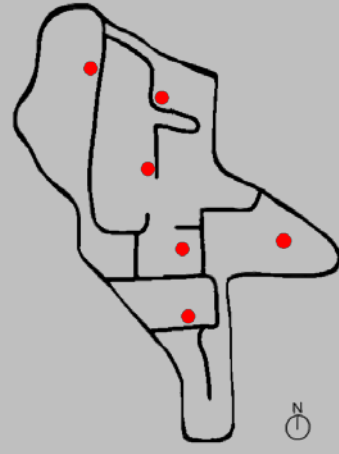
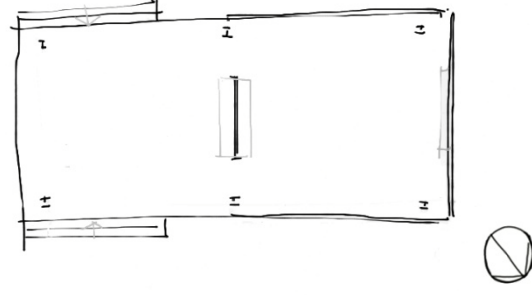
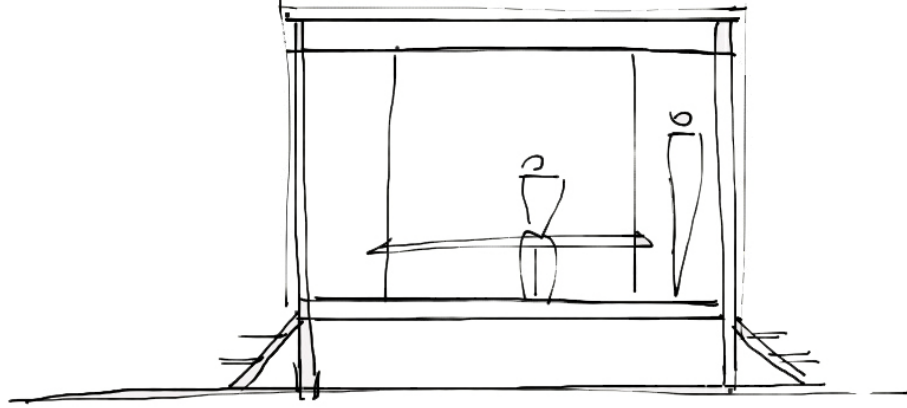

área-objeto

01 . 02 . 03 . 04 . 05 . **06** . 07

e1 . letícia

elevação sudeste

sistema expositivo móvel

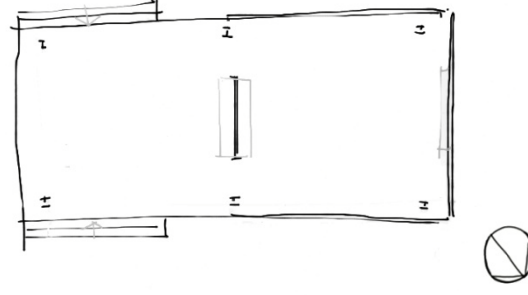
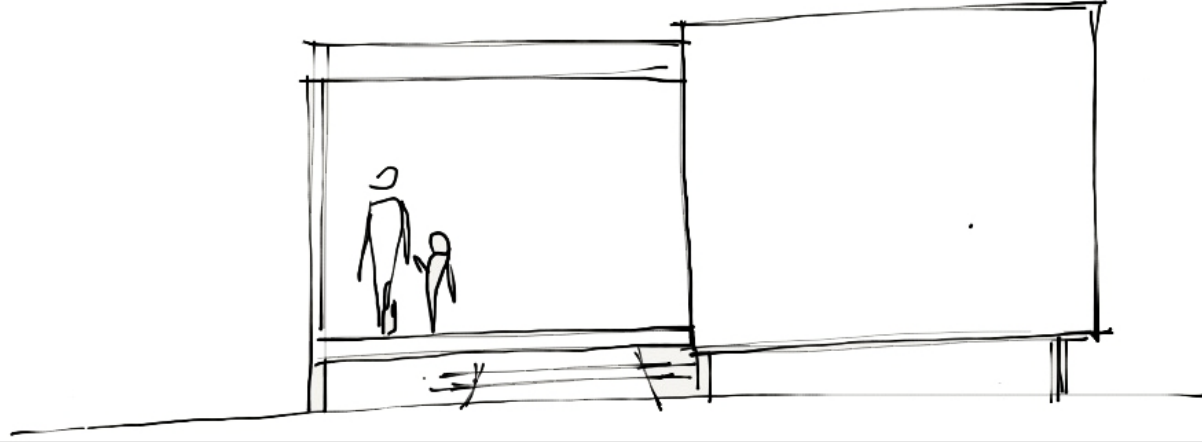

área-objeto

01 . 02 . 03 . 04 . 05 . **06** . 07

e1 . letícia

elevação nordeste

sistema expositivo móvel

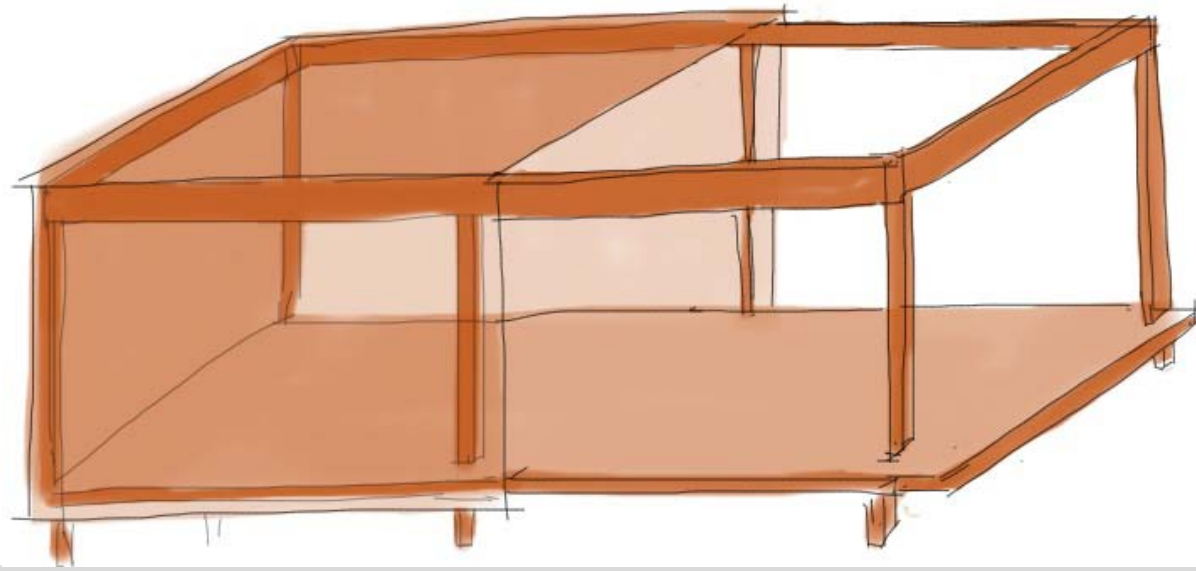

área-objeto

01 . 02 . 03 . 04 . 05 . **06** . 07

e1 . letícia

perspectiva

sistema expositivo móvel

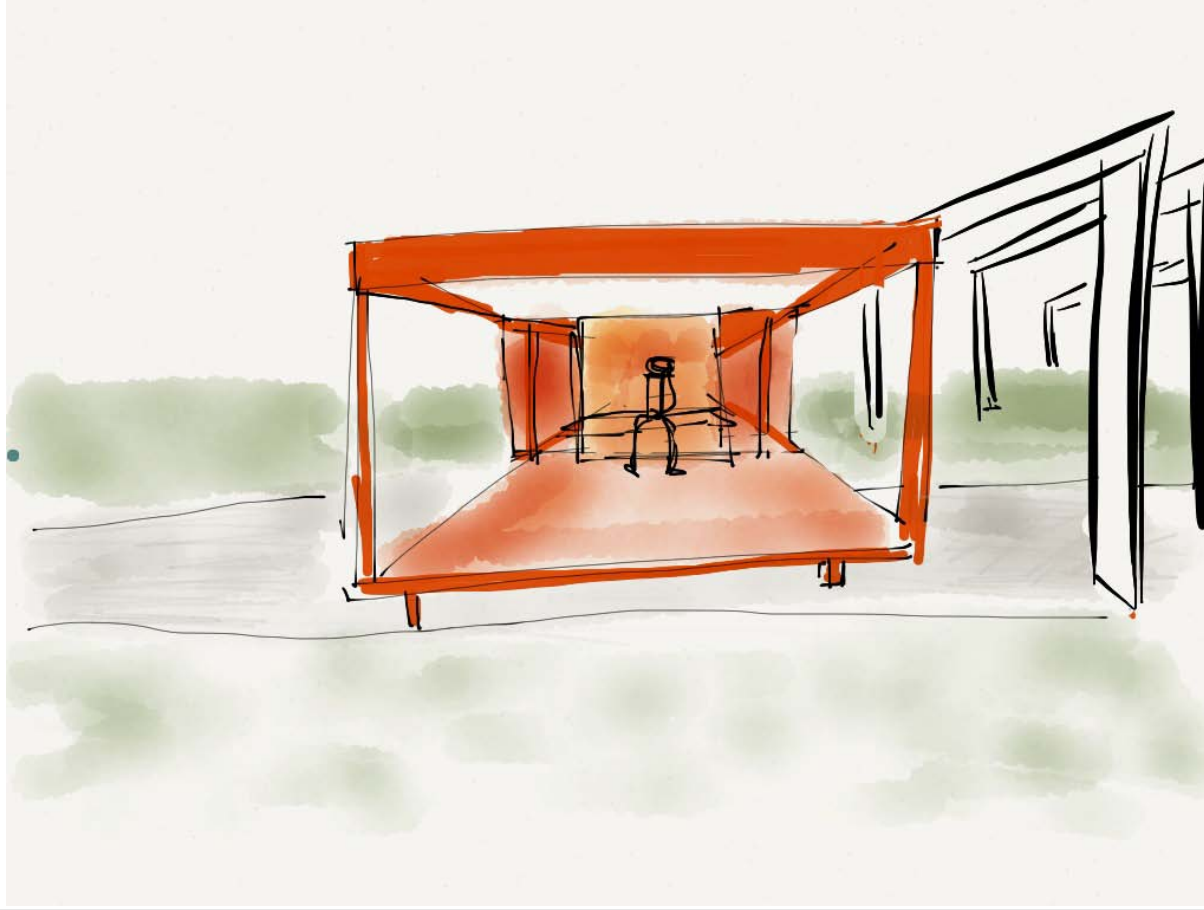

área-objeto

01 . 02 . 03 . 04 . 05 . **06** . 07

e1 . letícia

perspectiva

sistema expositivo móvel

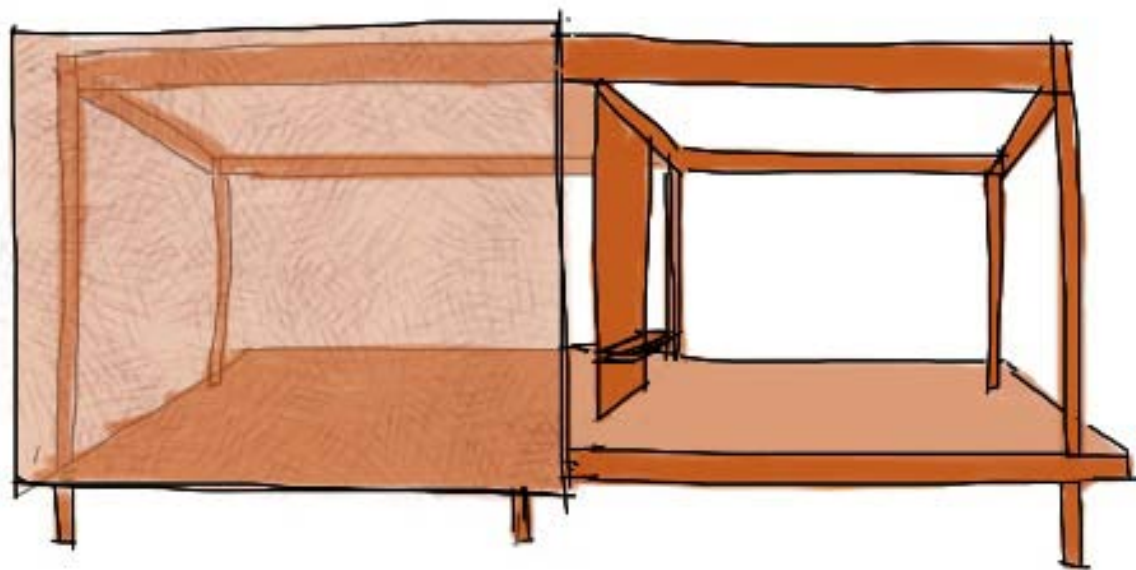

e1 . letícia
perspectiva

sistema expositivo móvel

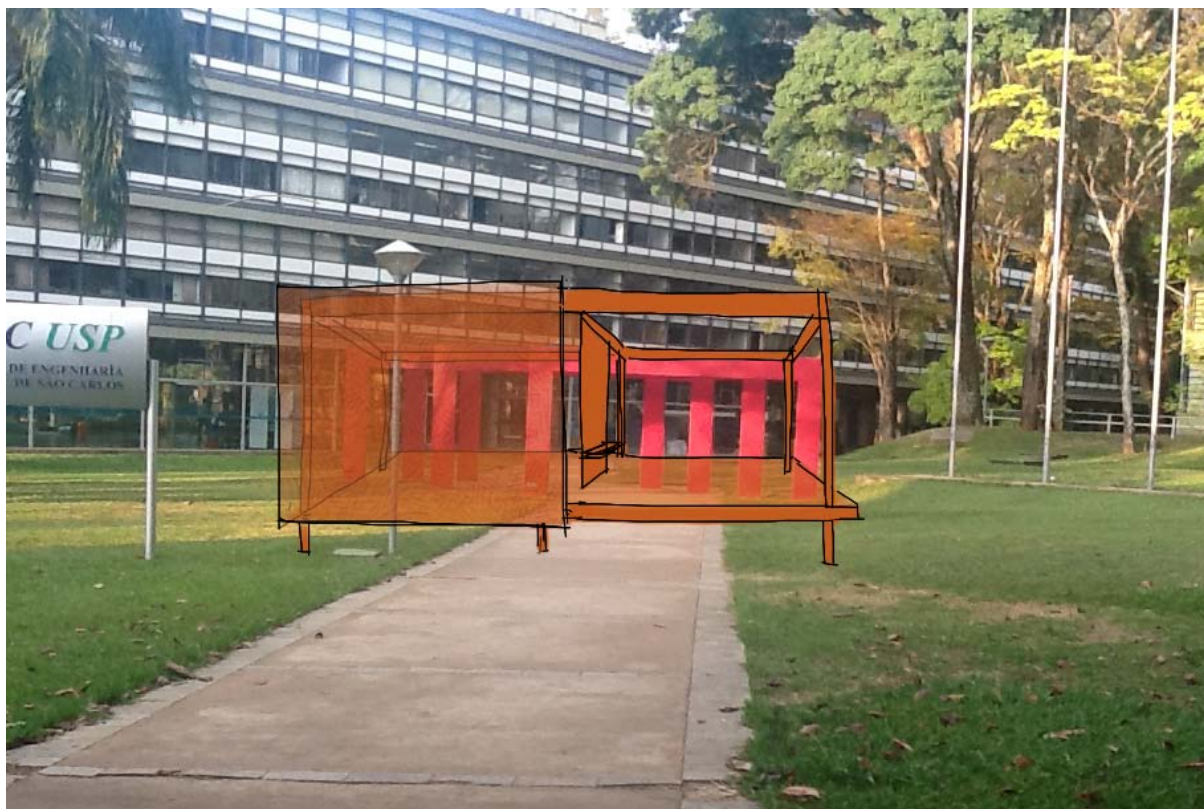

área-objeto

01 . 02 . 03 . 04 . 05 . **06** . 07

e1 . letícia

montagem

sistema expositivo móvel

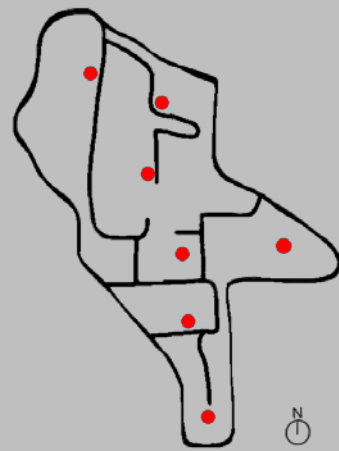

área-objeto

01 . 02 . 03 . 04 . 05 . 06 . 07

observatório . paula
implantação

sistema expositivo móvel

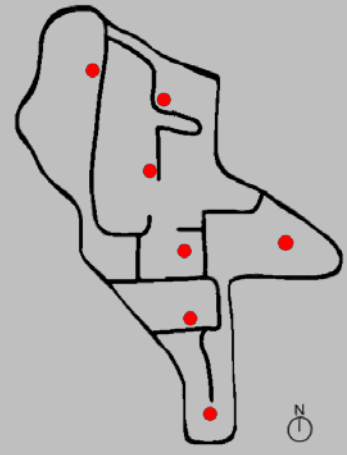
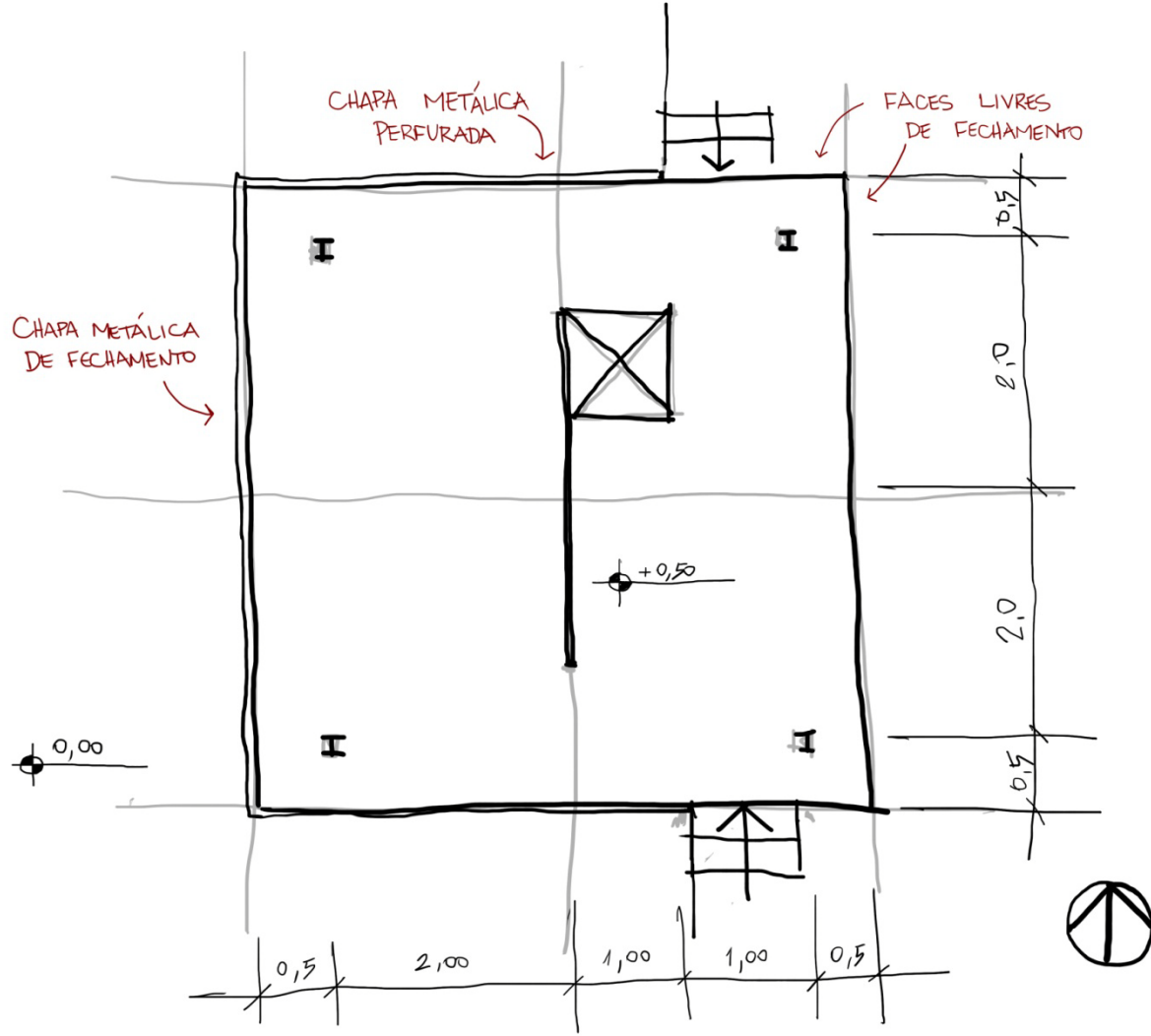

área-objeto

01 . 02 . 03 . 04 . 05 . 06 . 07

observatório . paula

planta baixa

sistema expositivo móvel

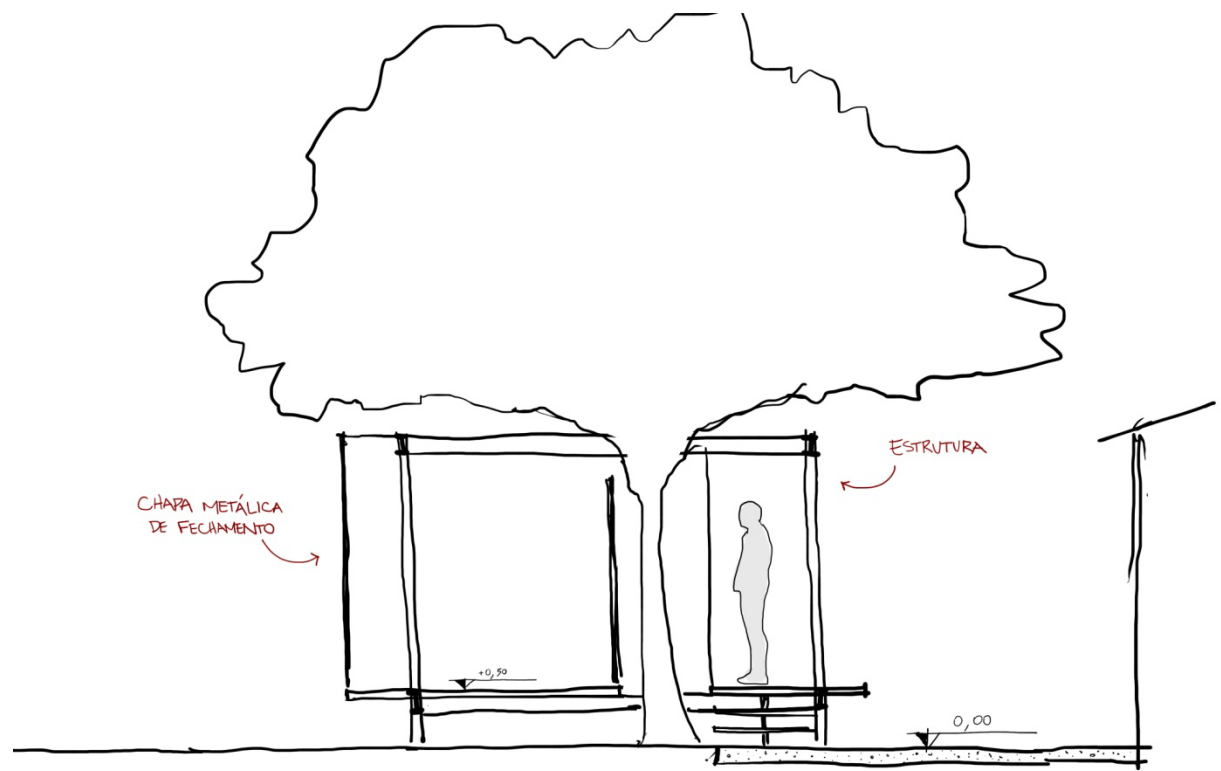
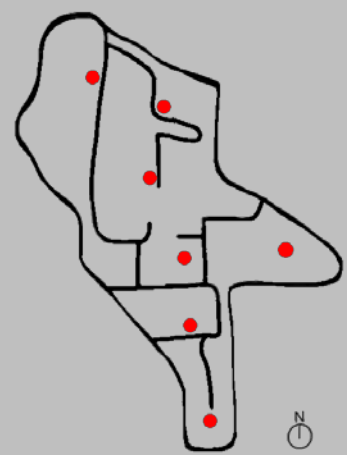
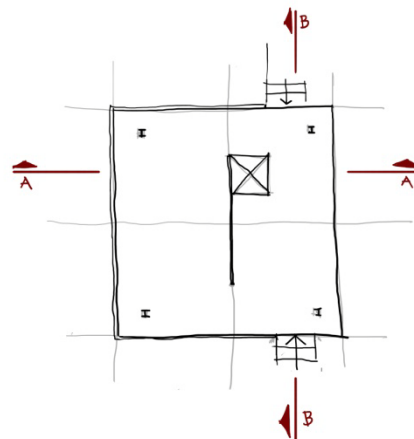

área-objeto
01 . 02 . 03 . 04 . 05 . 06 . 07

observatório . paula
corte A-A

sistema expositivo móvel

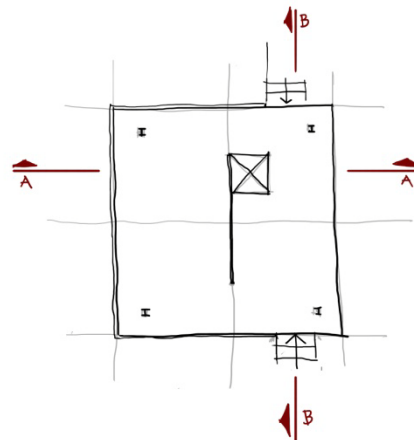
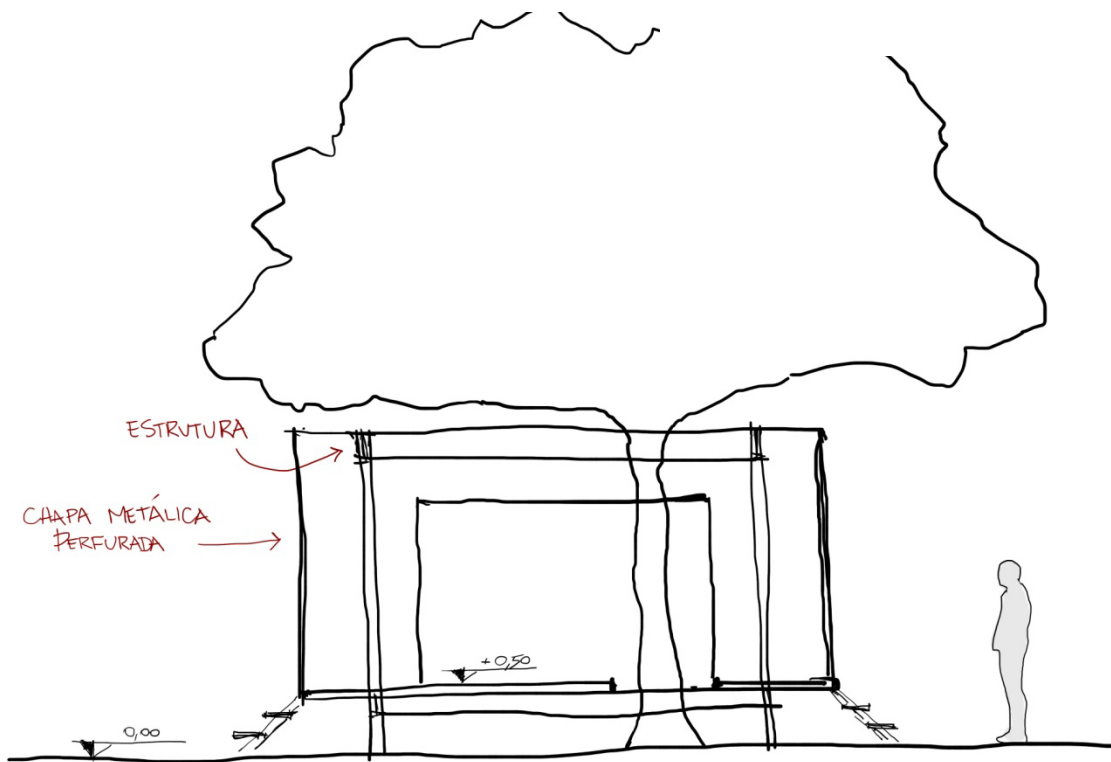

área-objeto

01 . 02 . 03 . 04 . 05 . 06 . 07

observatório . paula

cutre B-B

sistema expositivo móvel

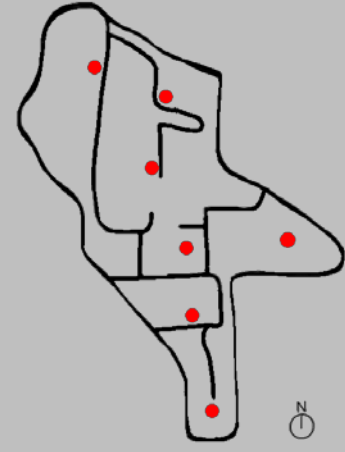
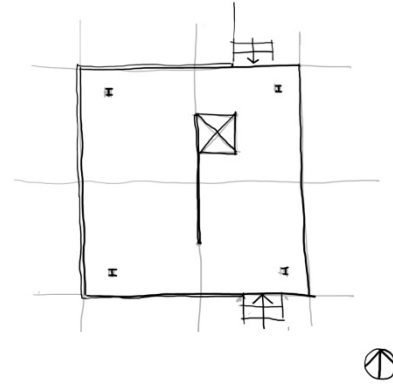
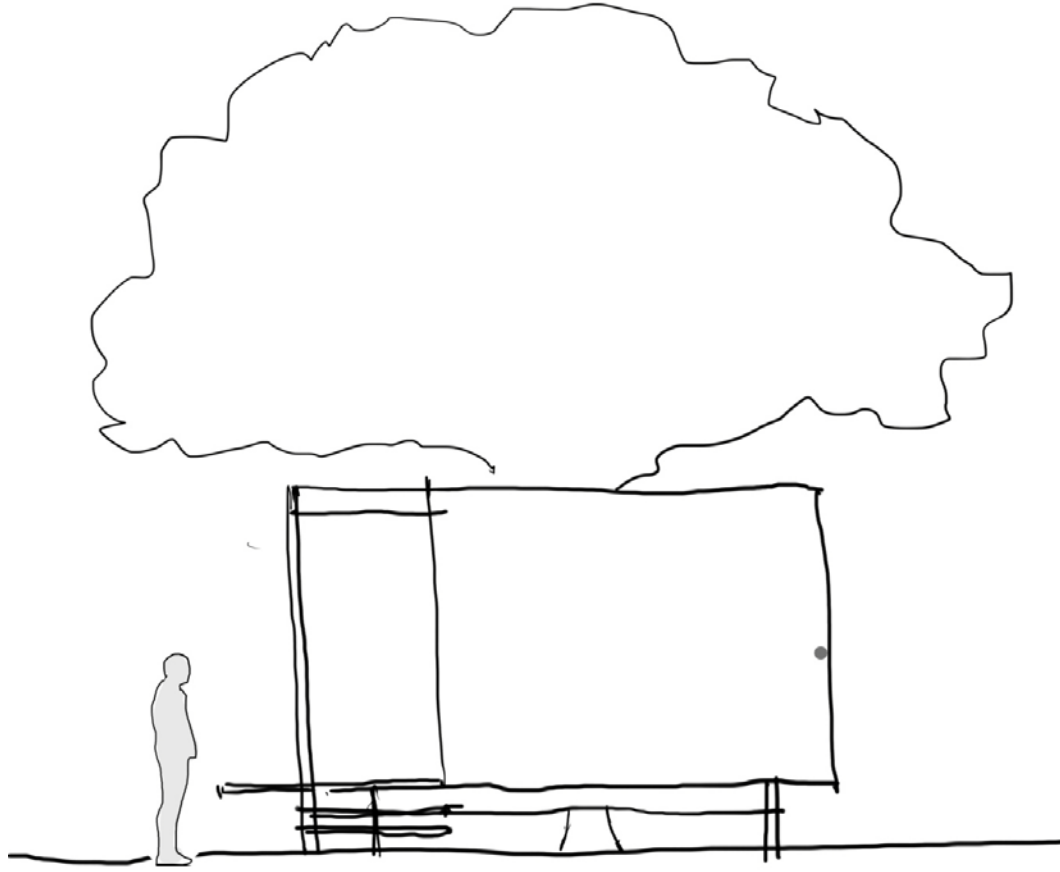

área-objeto

01 . 02 . 03 . 04 . 05 . 06 . 07

observatório . paula

elevação norte

sistema expositivo móvel

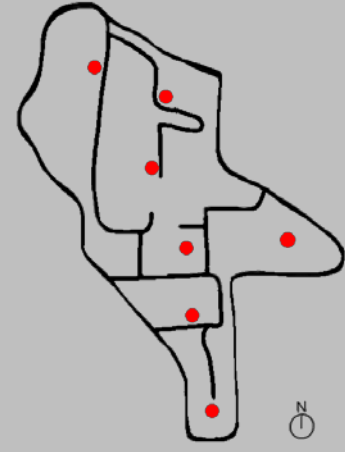
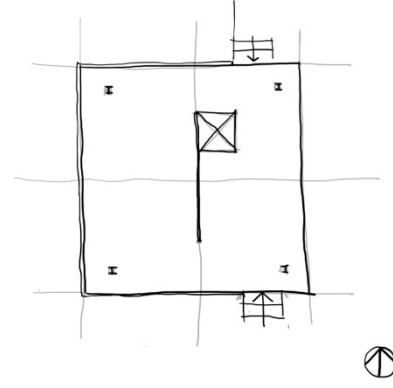
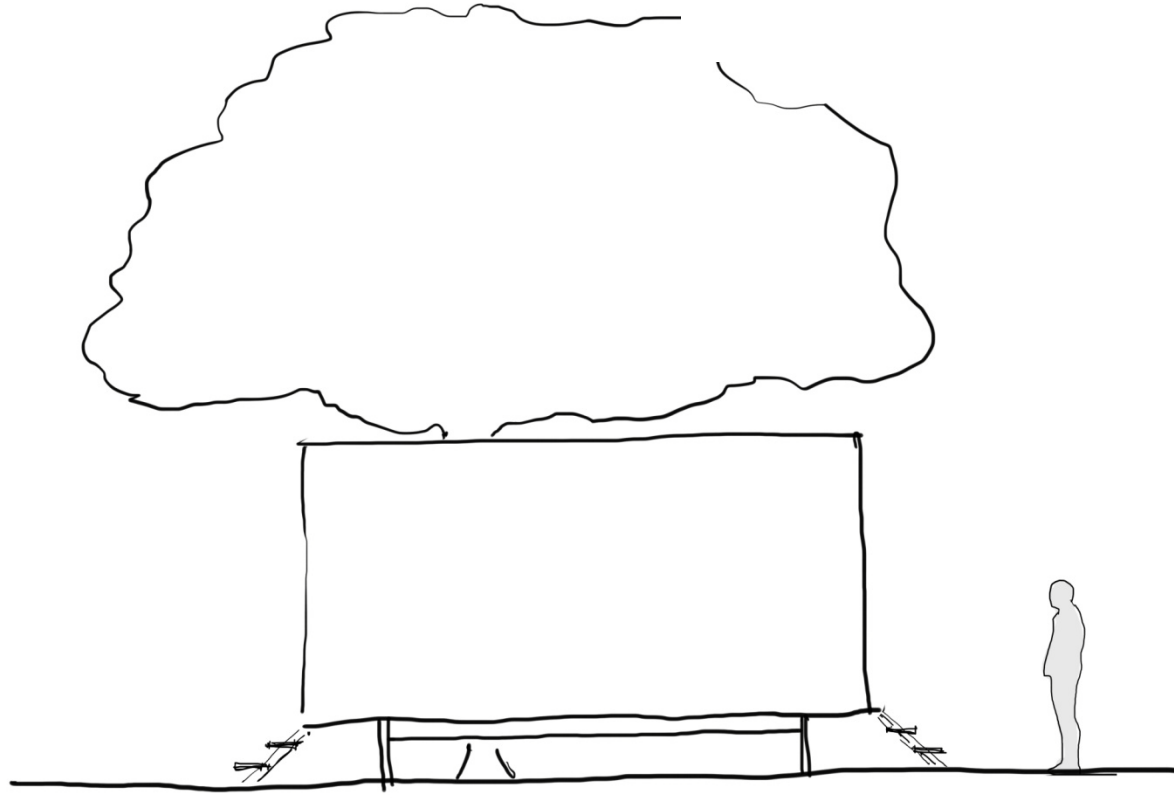

área-objeto

01 . 02 . 03 . 04 . 05 . 06 . 07

observatório . paula

elevação oeste

sistema expositivo móvel

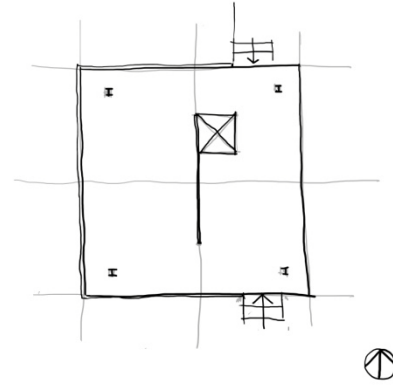
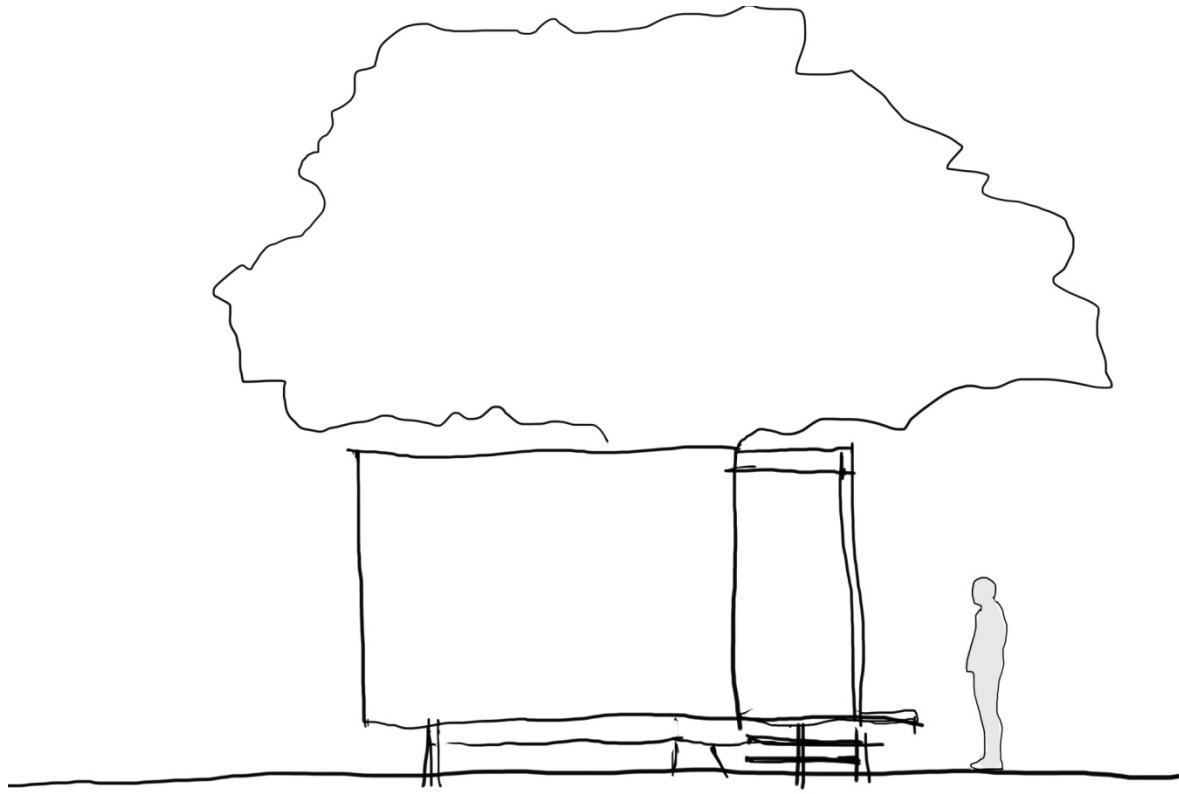

área-objeto

01 . 02 . 03 . 04 . 05 . 06 . 07

observatório . paula

elevação sul

sistema expositivo móvel

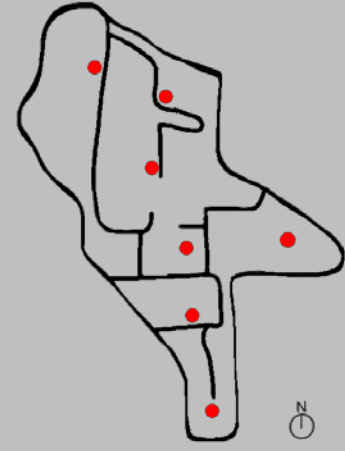
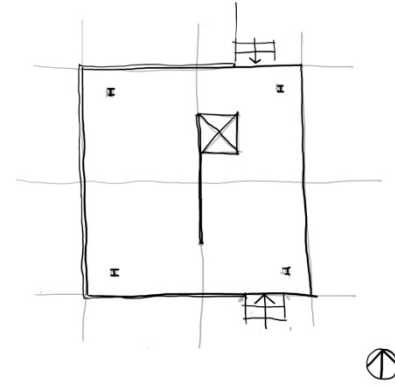
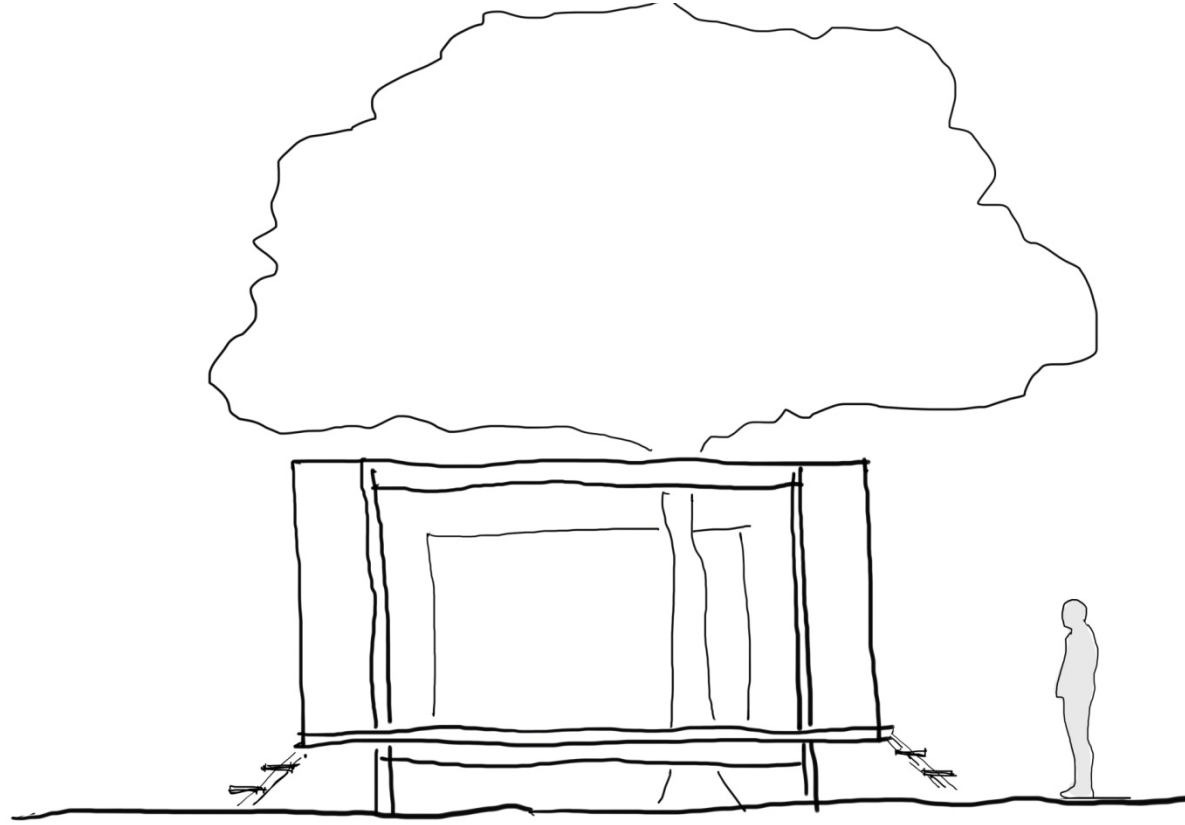

área-objeto

01 . 02 . 03 . 04 . 05 . 06 . 07

observatório . paula

elevação lesta

sistema expositivo móvel

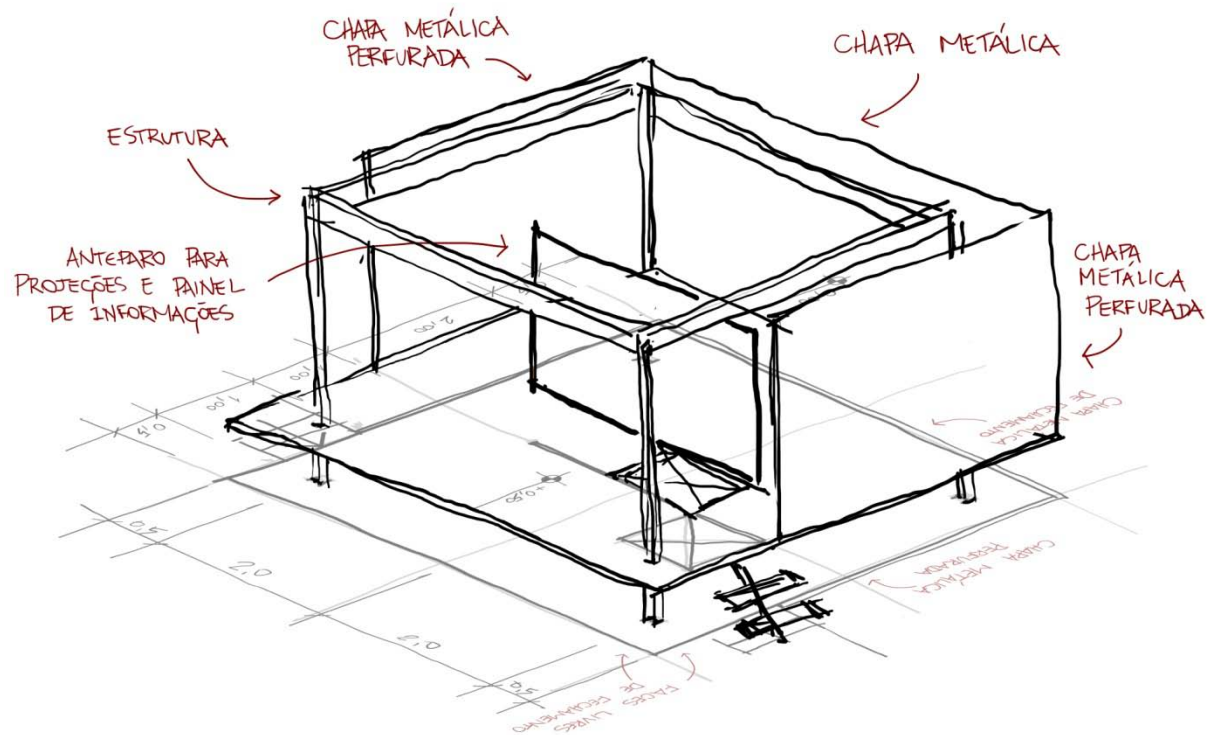

área-objeto

01 . 02 . 03 . 04 . 05 . 06 . 07

observatório . paula

perspectiva

sistema expositivo móvel

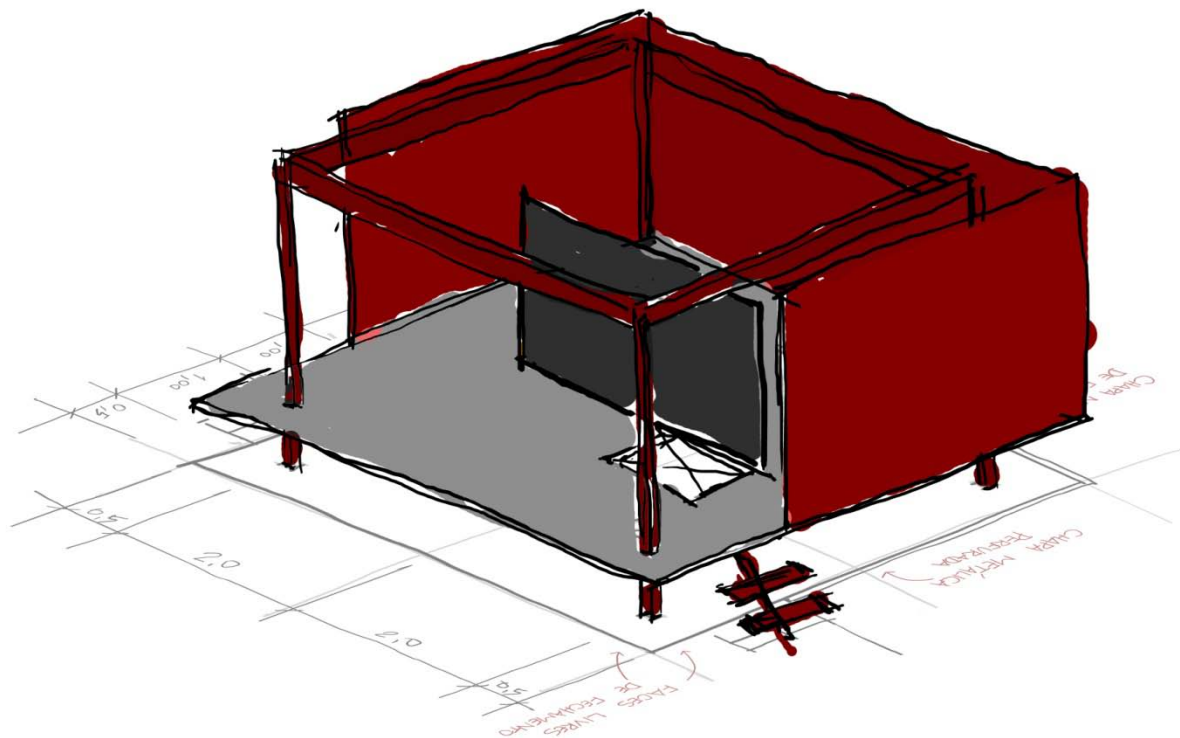

área-objeto

01 . 02 . 03 . 04 . 05 . 06 . 07

observatório . paula

perspectiva

sistema expositivo móvel



área-objeto

01 . 02 . 03 . 04 . 05 . 06 . 07

observatório . paula

montagem

sistema expositivo móvel

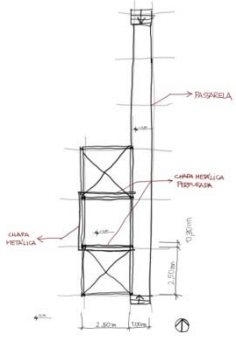

área-objeto 01

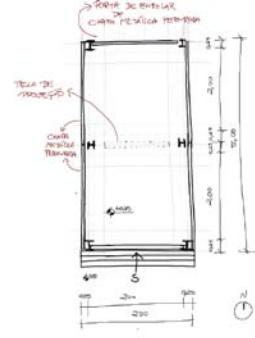

área-objeto 02

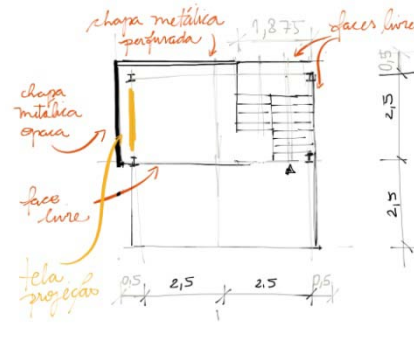

área-objeto 03

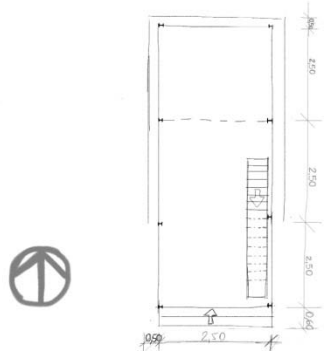

área-objeto 04



área-objeto 05



área-objeto 06

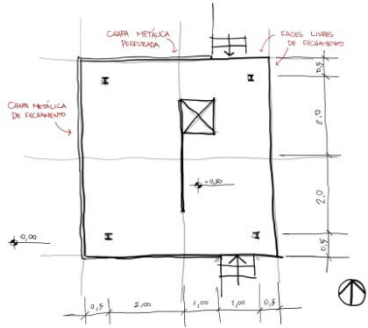

área-objeto 07

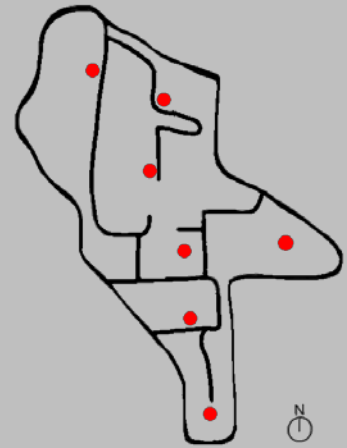

nosso
sistema expositivo móvel
plantas

sistema expositivo móvel

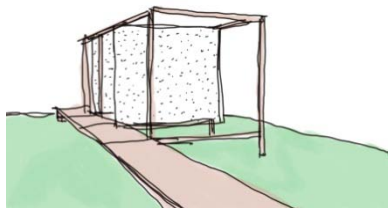

área-objeto 01

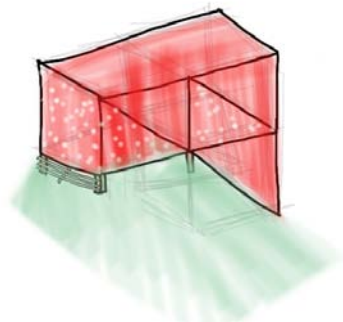

área-objeto 02

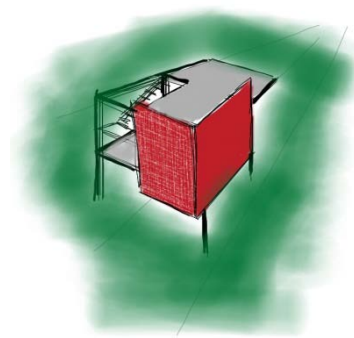

área-objeto 03

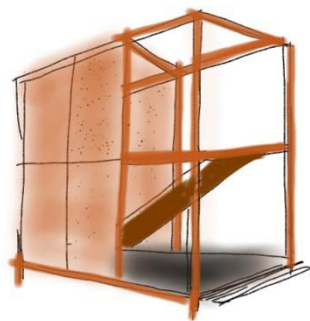

área-objeto 04



área-objeto 05

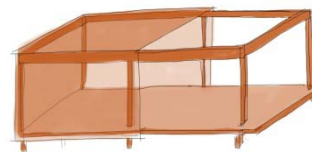

área-objeto 06

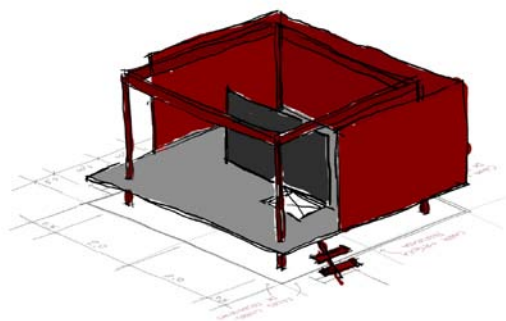

área-objeto 07

nosso sistema expositivo móvel perspectivas

sistema expositivo móvel



área-objeto 01

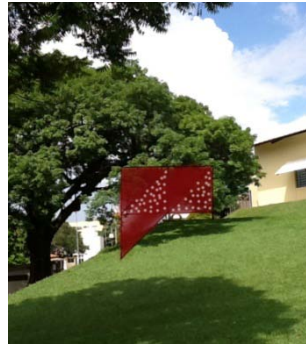

área-objeto 02



área-objeto 03



área-objeto 04



área-objeto 05

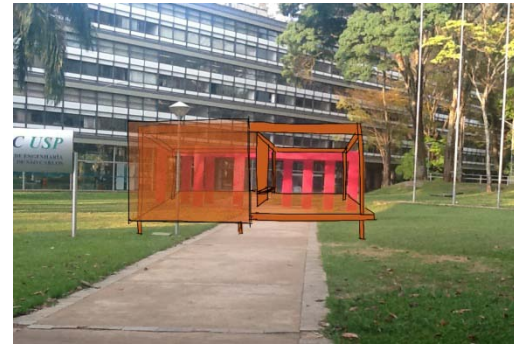

área-objeto 06



área-objeto 07



nosso sistema expositivo móvel montagens

sistema expositivo móvel